

KALDEWEI

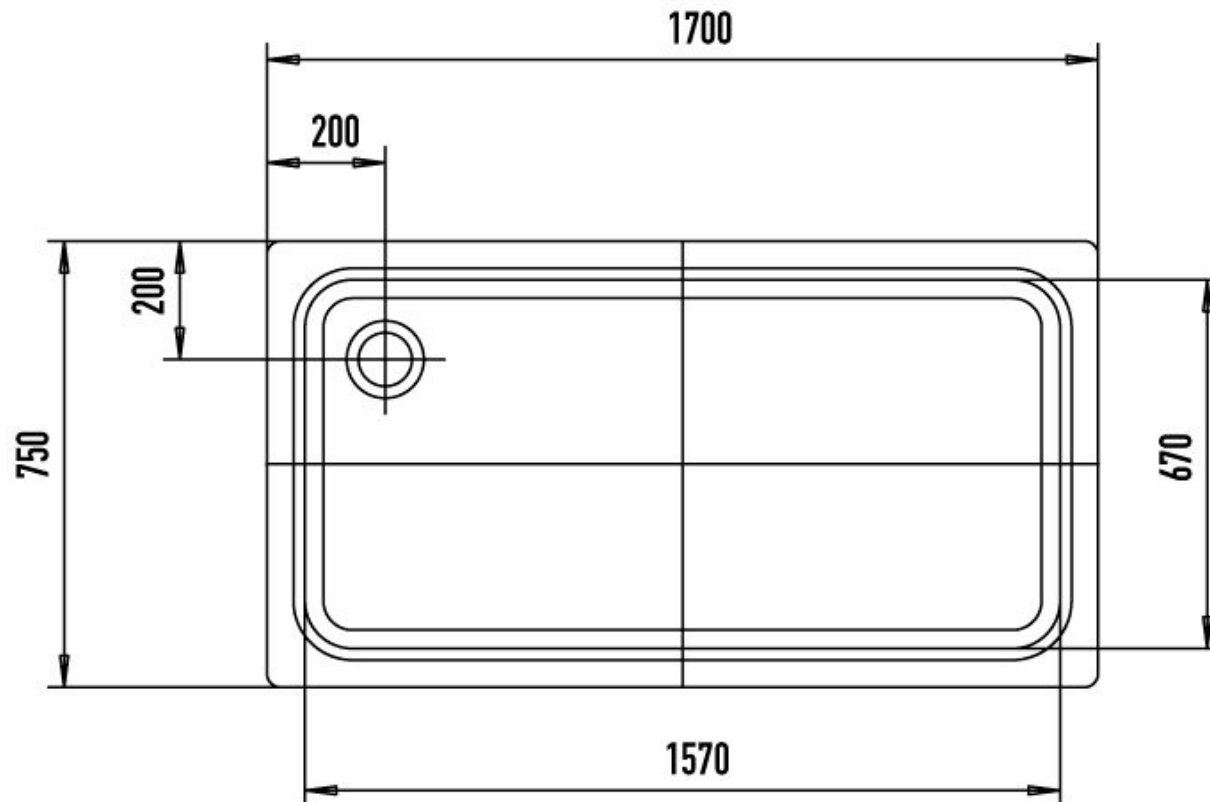

**DUSCHPLAN
426-1**