

KALDEWEI

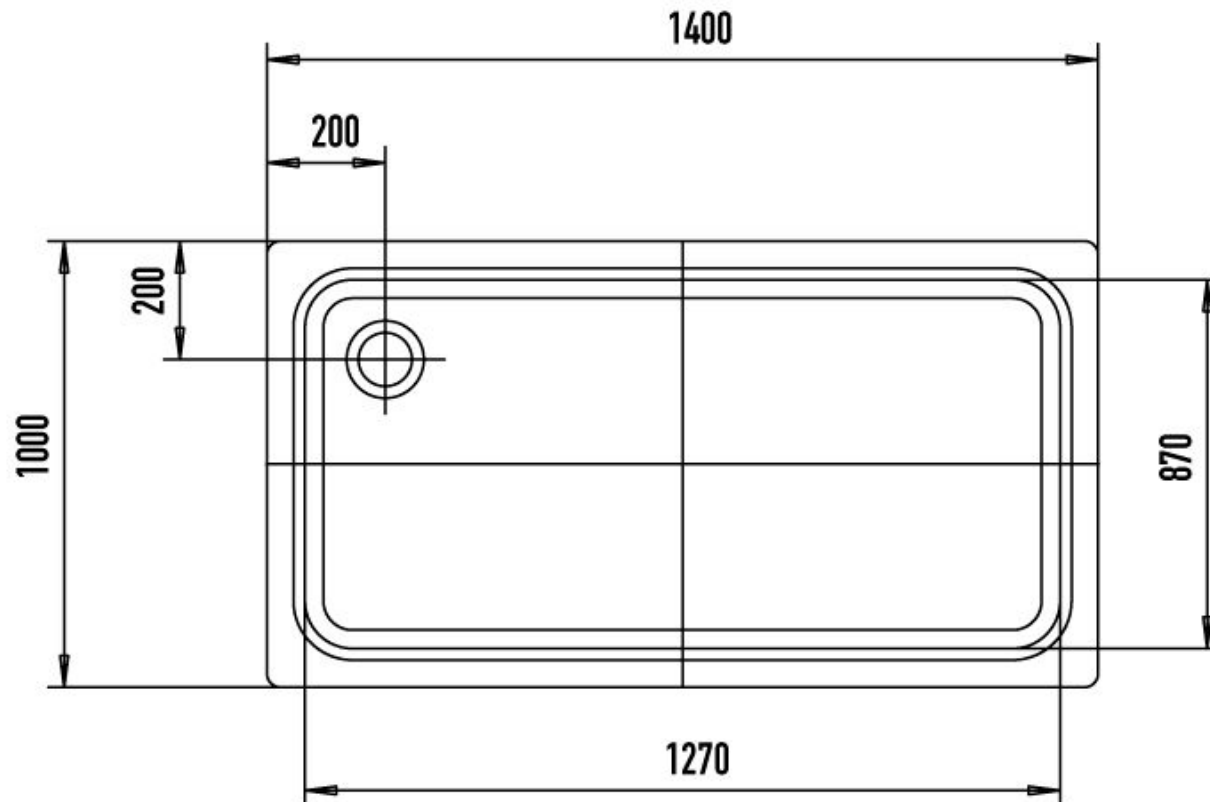

**DUSCHPLAN
427-1**