

AHS 30 Variante

Montageanleitung / Notice de montage / Assembly instruction

Flex-Well Vertriebs GmbH & Co.KG
 Industriestr. 80
 32120 Hiddenhausen
 info@flex-well.de

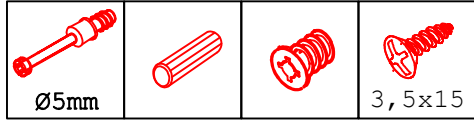

12x 34x 20x 10x



12x

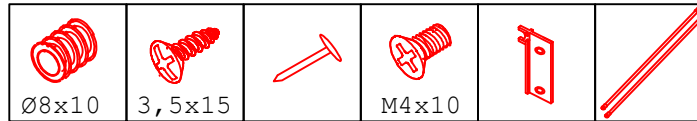

20x 56x 15x 20x 8x 4x

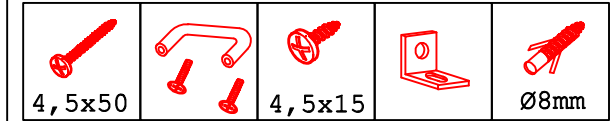

1x 2x 1x 1x 1x

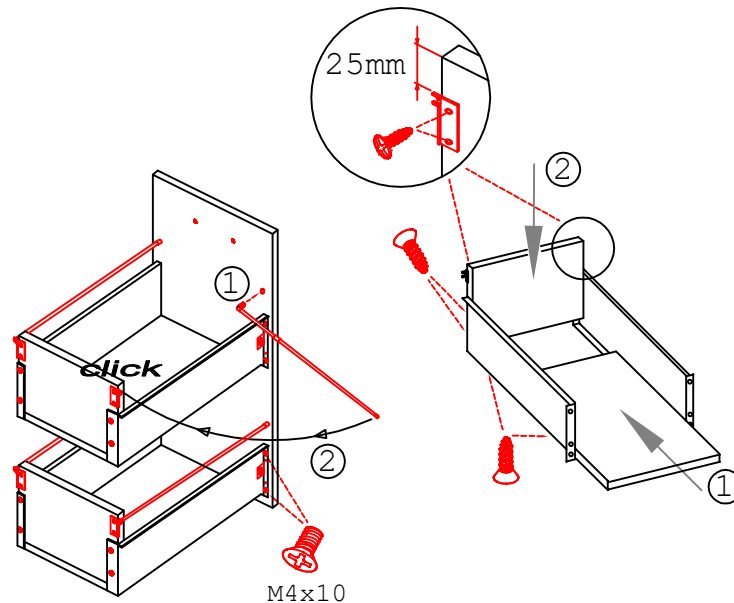
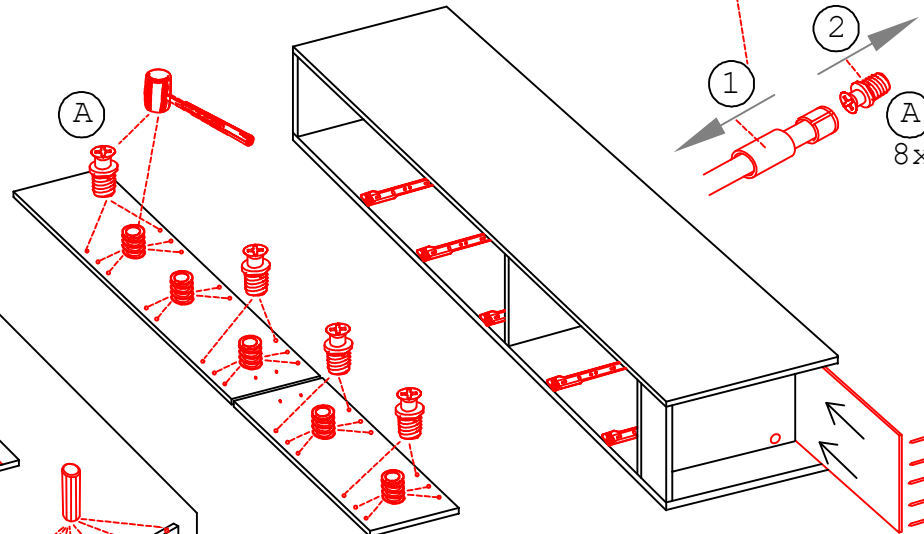
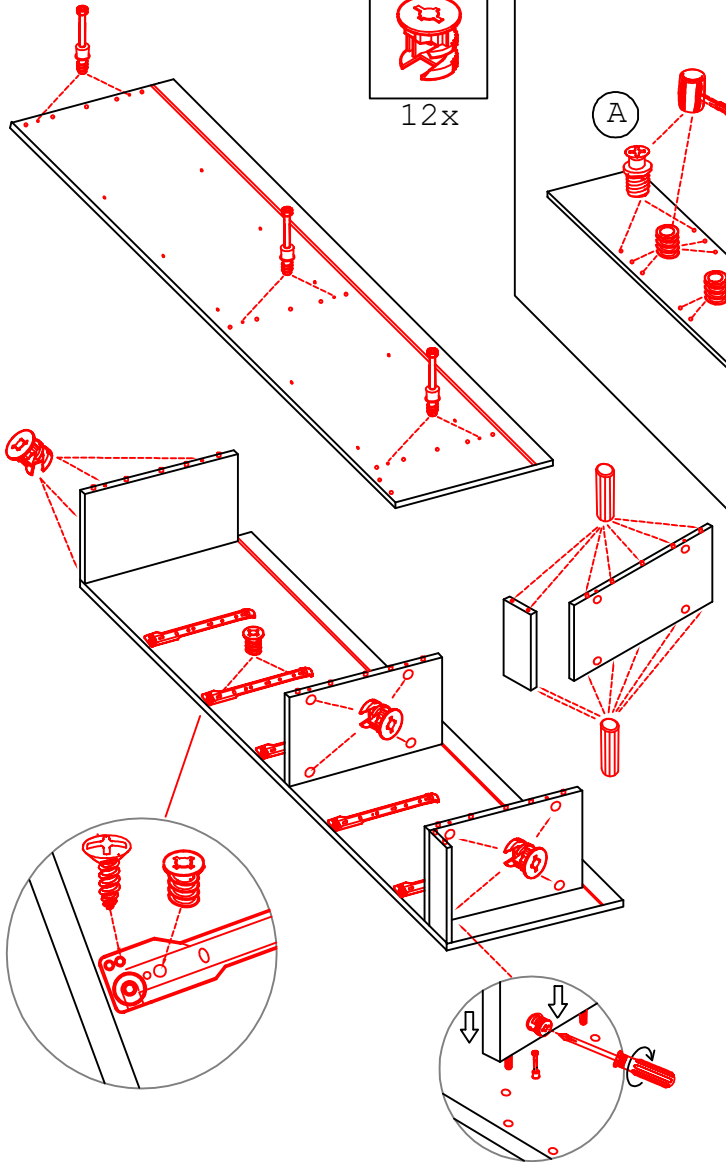

M4x10

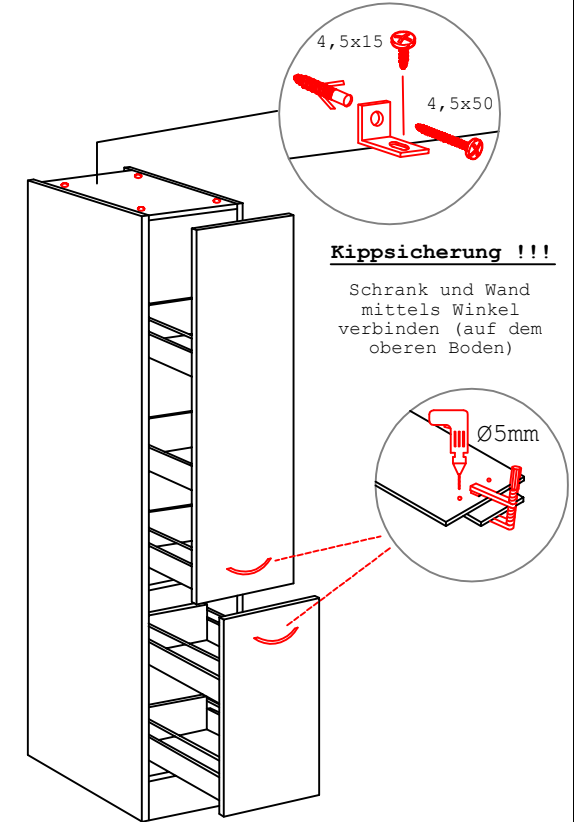

Kippsicherung !!!

Schrank und Wand
 mittels Winkel
 verbinden (auf dem
 oberen Boden)

Die Einstellung der
 Auszug-Blenden bitte
 durch drehen an den
 einzelnen Reihling-
 stangen vornehmen.
 (heranholen oder
 wegdrücken)

