

AUFBAUANLEITUNG

„Frühbeetaufsatz“

- ⓔⓃ Assembly manual for “cold frame extension”
- ⓕⓇ Notice de montage du “serre”
- ⓃⓁ Opbouwbeschrijving voor “serre”
- ⓔⓈ Instrucciones de montaje de “Semillero superpuesto”
- ⓔⓣ Istruzioni di montaggio “sopralzo”
- Ⓝⓐ Monteringsvejledning for “mistbænk”
- ⓈⓋ Monteringsanvisning för “drivbänk”
- Ⓝⓓ Monteringsanvisning for “Drivhus”
- ⓅⓁ Instrukcja montażu “Nakładka na Grządke Podwyższoną”
- ⓈⓀ Montážny návod pre “Pareniskový nadstavec”
- ⓈⓁ Priročnik za montažo “Zaščita proti zmrzali”
- ⓐⓈ Montážní návod pro “Rám proti mrazu”
- ⓗⓤ Felépítési útmutató “Melegágy-feltét”
- ⓗⓇ Priručnik za montažu za “nastavak za proljetnu gredicu”
- Ⓡⓞ Manual asamblare pentru “Rama extinsa pentru inghet”

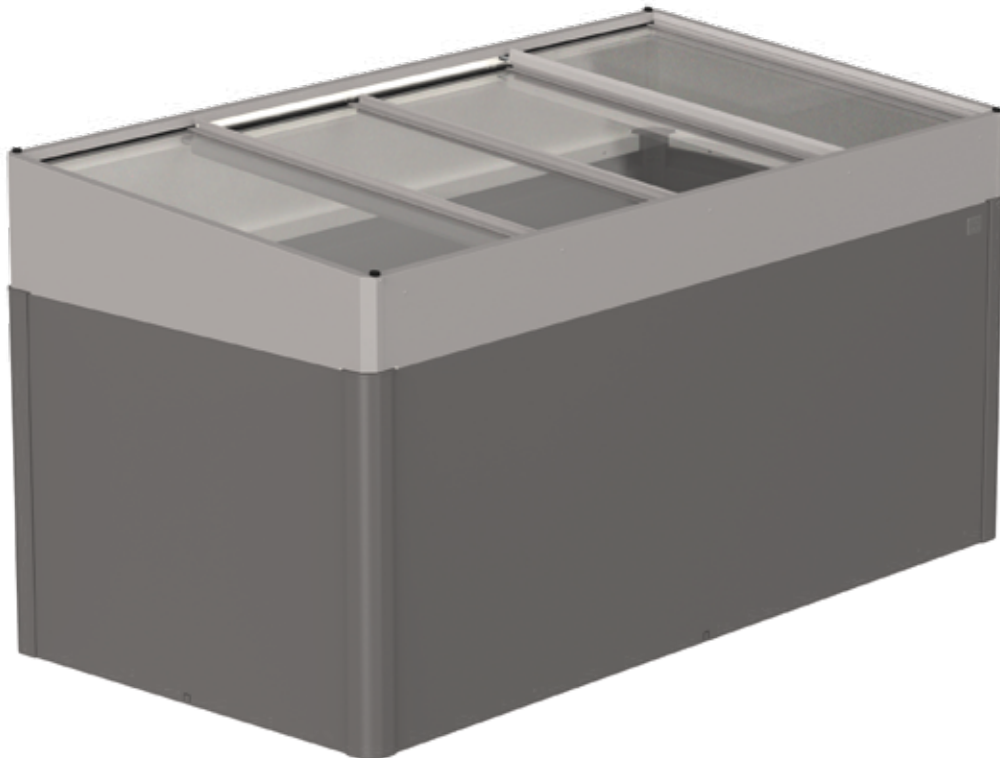

VERWENDEN SIE BEI DER MONTAGE ARBEITSHANDSCHUHE! UM KRATZER ZU VERMEIDEN, VERWENDEN SIE BITTE GEEIGNETE UNTERLAGEN!

- (GB)** Wear working gloves! Please use a suitable underlay to avoid scratches!
- (FR)** Portez des gants de travail! Pour éviter les rayures, utilisez des supports appropriés !
- (NL)** Handschoenen gebruiken! Om krassen te voorkomen raden wij u aan er iets onder te leggen!
- (ES)** Utilice unos guantes de trabajo. Por favor, coloque en el suelo una base protectora adecuada para evitar posibles arañazos.
- (IT)** Utilizzare guanti da lavoro. Utilizzare una base adatta per evitare graffi!
- (DK)** Brug arbejdshandsker! Brug et passende underlag for at undgå ridser!
- (SE)** Använd arbetshandskar under monteringen! Använd lämpliga underlag för att undvika repor!
- (NO)** Bruk arbeidshansker! Bruk et passende underlag for å unngå riper!
- (PL)** Podczas montażu proszę używać rękawice ochronne. Chronić powierzchnię lakierowaną przed zarysowaniami.
- (SK)** Používajte pracovné rukavice! Prosím, použite vhodnú podložku, aby ste zabránili poškrábaniu!
- (SI)** Uporabite delovne rokavice! Uporabite ustrezno podlago, da se izognete praskam!
- (CZ)** Při montáži používejte pracovní rukavice! Použijte vhodné podložky, abyste se vyhnuli poškrábání!
- (HU)** Szerelésnél használjon védőkesztyűt! A karcolások elkerülése érdekében használjon megfelelő alátétetket!
- (HR)** Nosite radne rukavice! Upotrijebite odgovarajuće podlagu, da se izognete praskam!
- (RO)** Purtati manusile de protectie! Va rog sa folositi o baza potrivita pentru a evita zgarieturile!

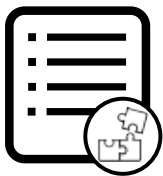

TEILEÜBERSICHT

Parts list · Liste des pièces · Stuklijst · Lista de piezas · Lista de parti · Deloversigt · Delöversikt · Del liste · Przegląd elementów · Zoznam dielov · Seznam delov · Seznam dílů · Tétélek áttekintése · Popis dijelova · Lista pieselor



TEILEÜBERSICHT

Parts list · Liste des pièces · Stuklijst · Lista de piezas · Lista de parti · Deloversigt · Delöversikt · Del liste · Przegląd elementów · Zoznam dielov · Seznam delov · Seznam dílů · Tétélek áttekintése · Popis dijelova

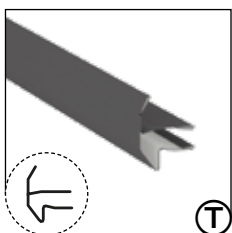
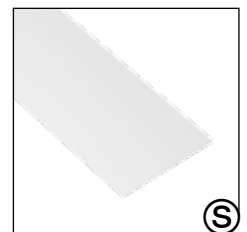
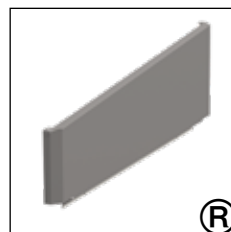
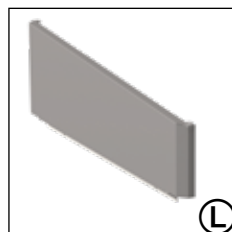
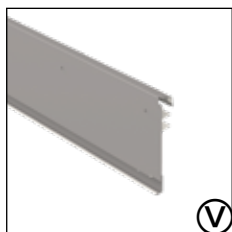
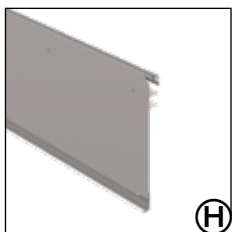

1.

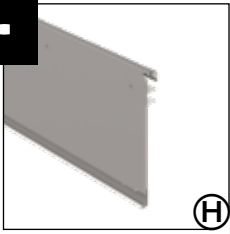

1x

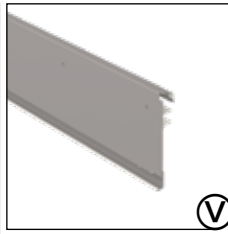

1x

3,9 x 9,5



4x



FESTZIEHEN

- (EN) tighten
- (FR) serrez fort
- (NL) vastdraaien
- (ES) apriete
- (IT) serrare a fondo
- (DA) fastspænding
- (SV) Dra åt
- (NO) Stramme
- (PL) Dokręcić
- (SK) Dotiahnuť
- (SL) Zategnite
- (CS) Dotáhnout
- (HU) Erősen meghúzni
- (HR) Zategnite
- (RO) Strangeti

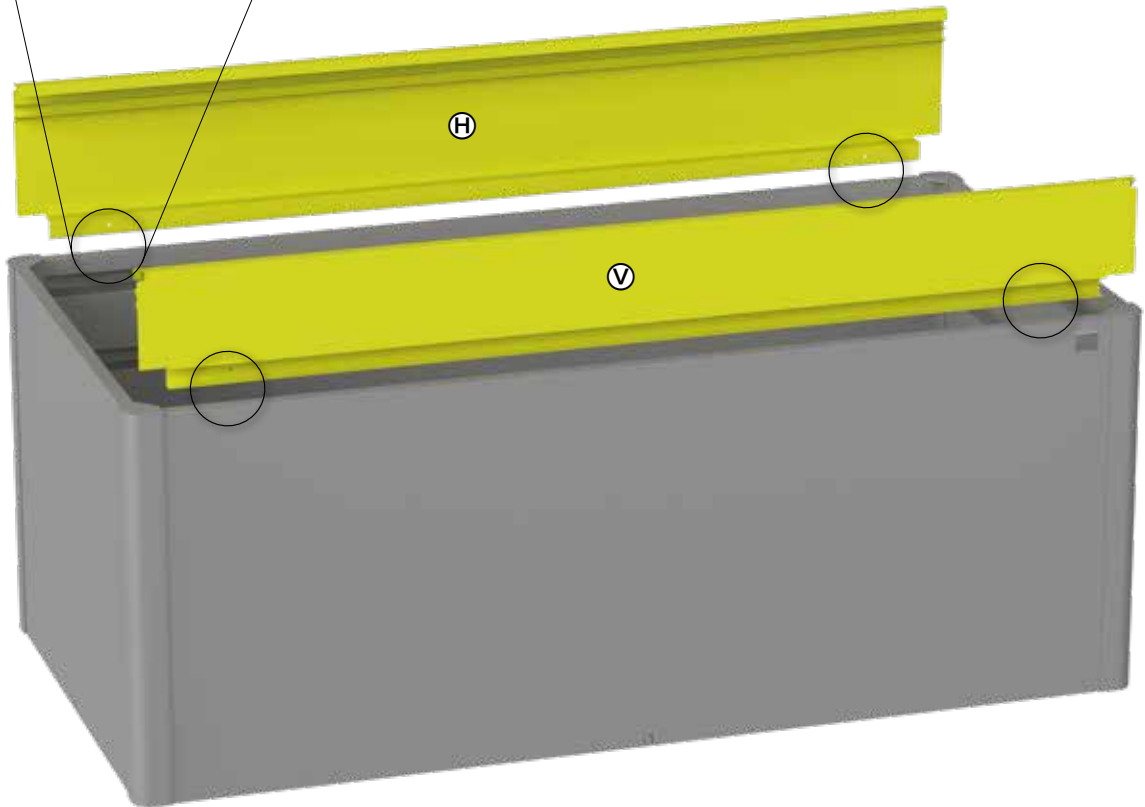
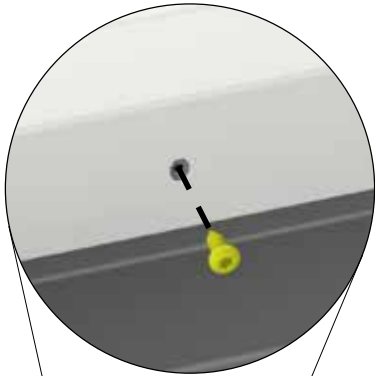

2.

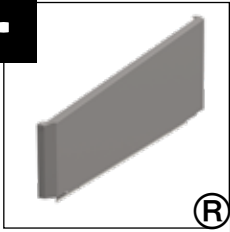

1x

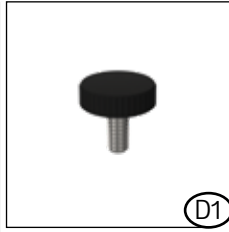

2x

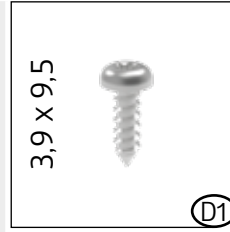

2x

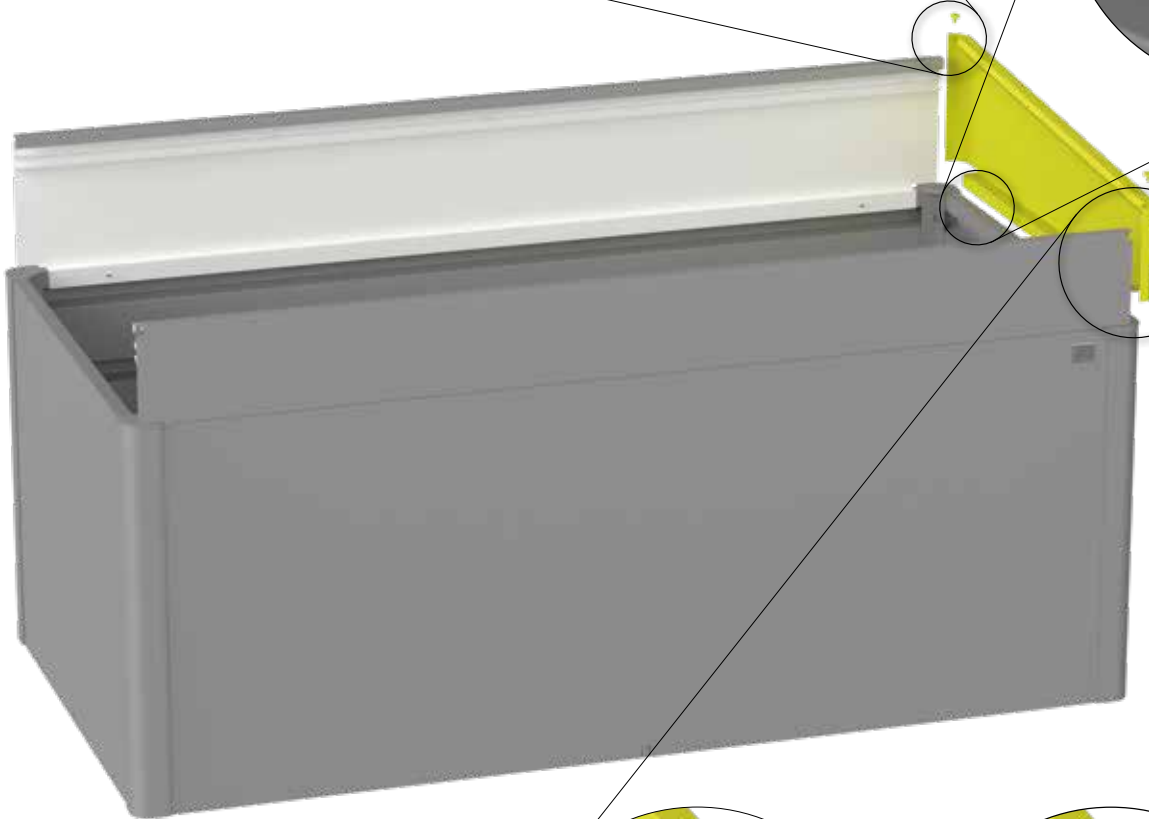
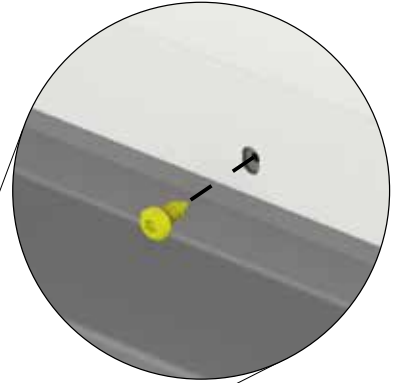

FESTZIEHEN

- (EN) tighten
- (FR) serrez fort
- (NL) vastdraaien
- (ES) apriete
- (IT) serrare a fondo
- (DA) fastspænding
- (SV) Dra åt
- (NO) Stramme
- (PL) Dokręcić
- (SK) Dotiahnuť
- (SL) Zategnite
- (CS) Dotáhnout
- (HU) Erősen meghúzni
- (HR) Zategnite
- (RO) Strangeti

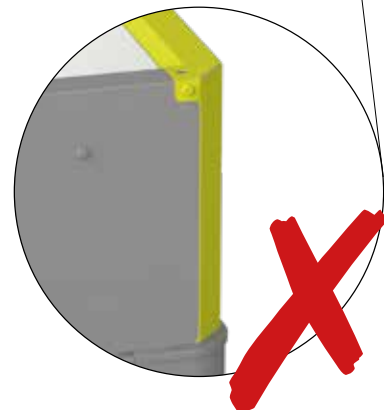
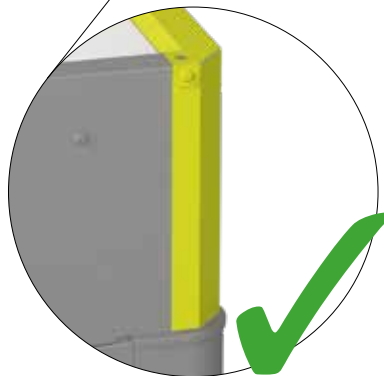

3.

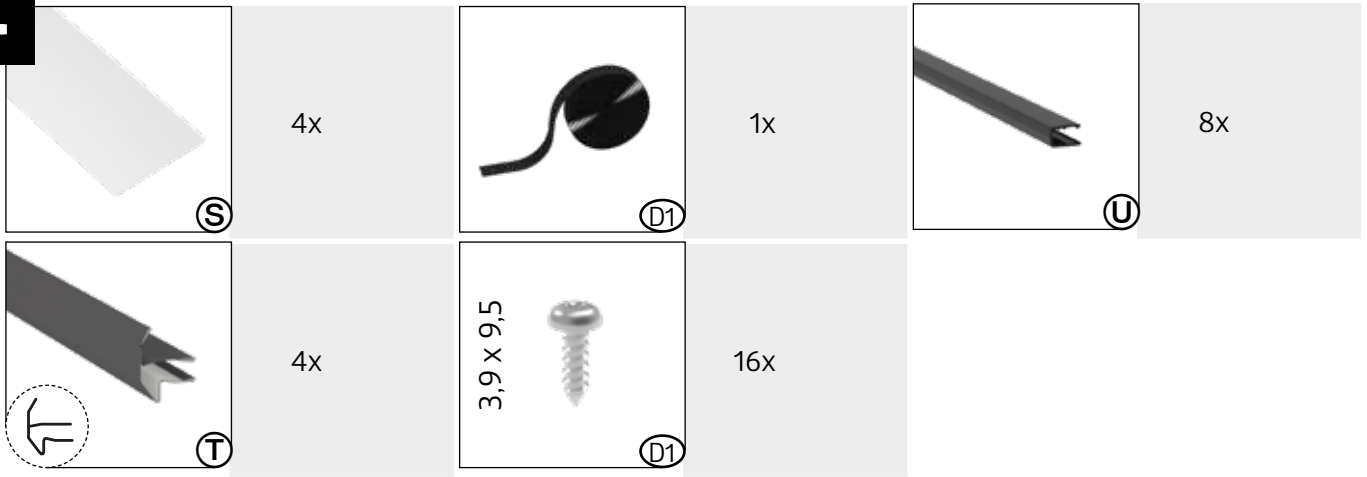

1.

SCHUTZFOLIE ABZIEHEN!

- (EN) Remove the protective film!
- (FR) Retirez le film protecteur !
- (NL) Verwijder de beschermfolie!
- (ES) ¡Retire la película protectora!
- (IT) Rimuovere la pellicola protettiva!
- (DA) Fjern beskyttelsesfilmen!
- (SV) Ta bort skyddsfilmen!
- (NO) Fjern beskyttelsesfilmen!
- (PL) Zdejmij folię ochronną!
- (SK) Odstráňte ochrannú fóliu!
- (SL) Odstranite zaščitno folijo!
- (CS) Odstraňte ochrannou fólii!
- (HU) Erősen meghúzni
- (HR) Távolítsa el a védőfóliát!
- (RO) Îndepărtați folia de protecție!

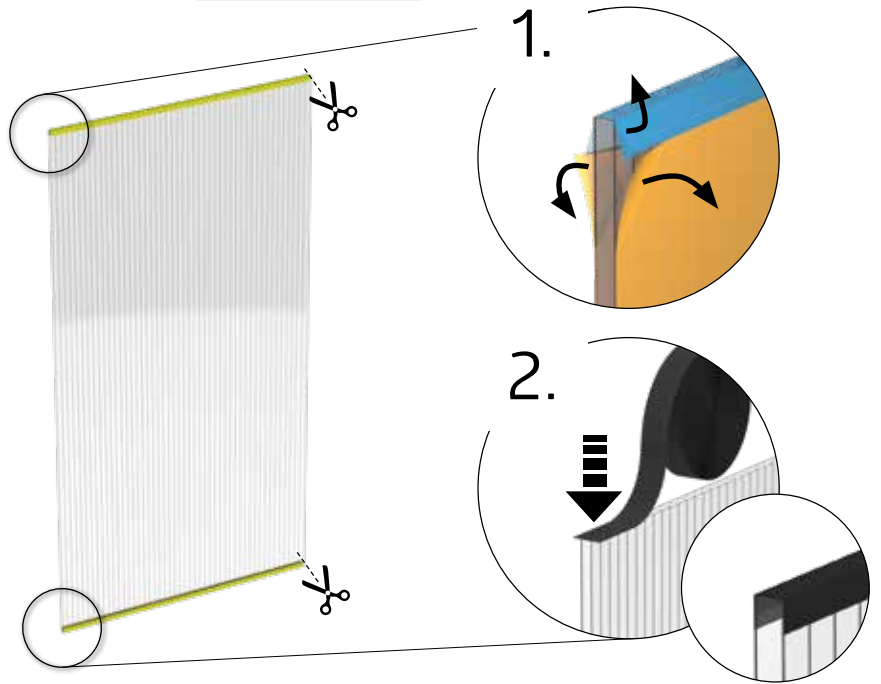

2.

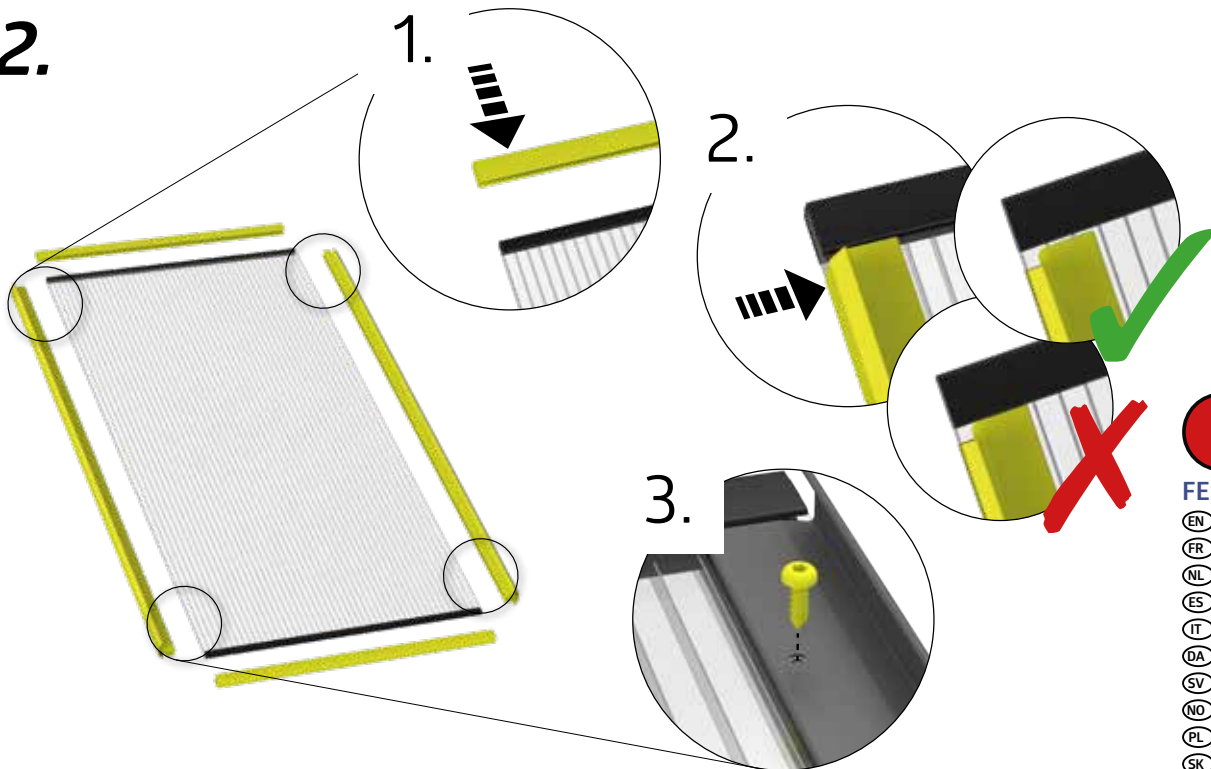

FESTZIEHEN

- (EN) tighten
- (FR) serrez fort
- (NL) vastdraaien
- (ES) apriete
- (IT) serrare a fondo
- (DA) fastspænding
- (SV) Dra åt
- (NO) Stramme
- (PL) Dokręcić
- (SK) Dotiahnuť
- (SL) Zategnite
- (CS) Dotáhnout
- (HU) Erősen meghúzni
- (HR) Zategnite
- (RO) Strangeti



4.

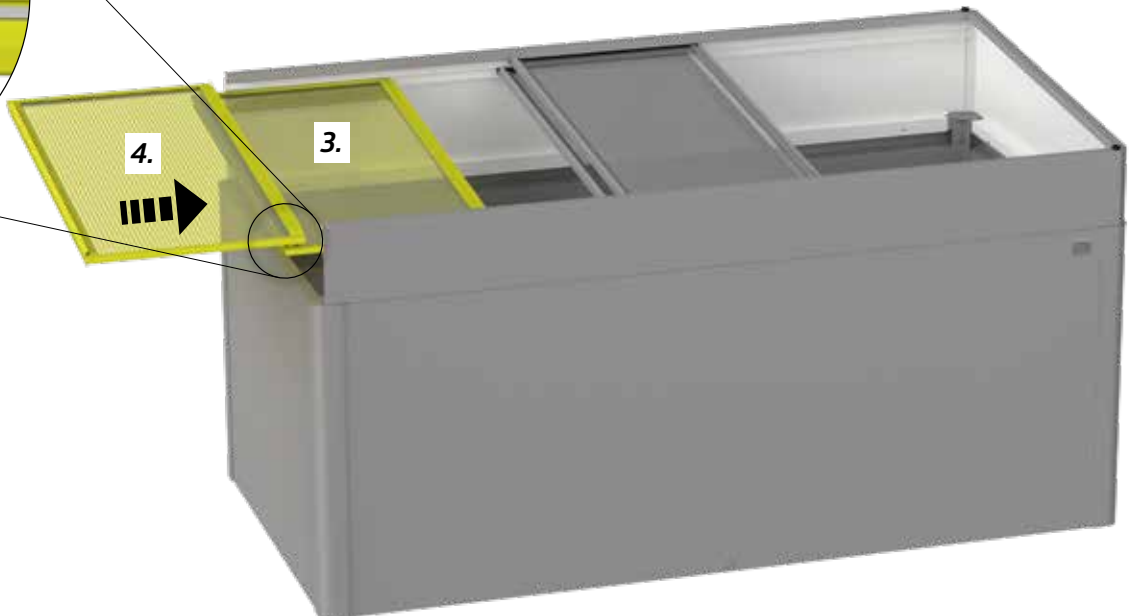
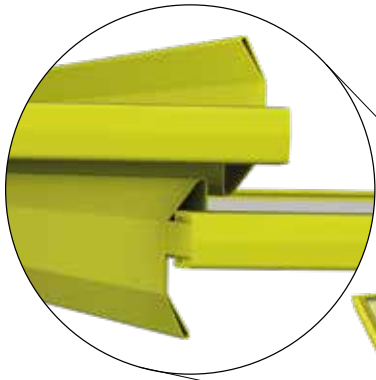
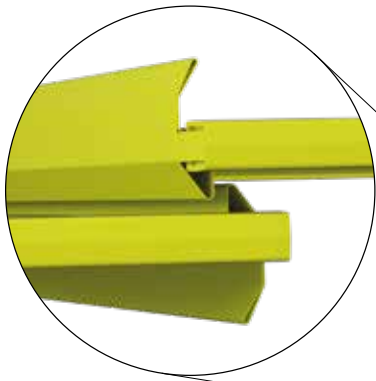
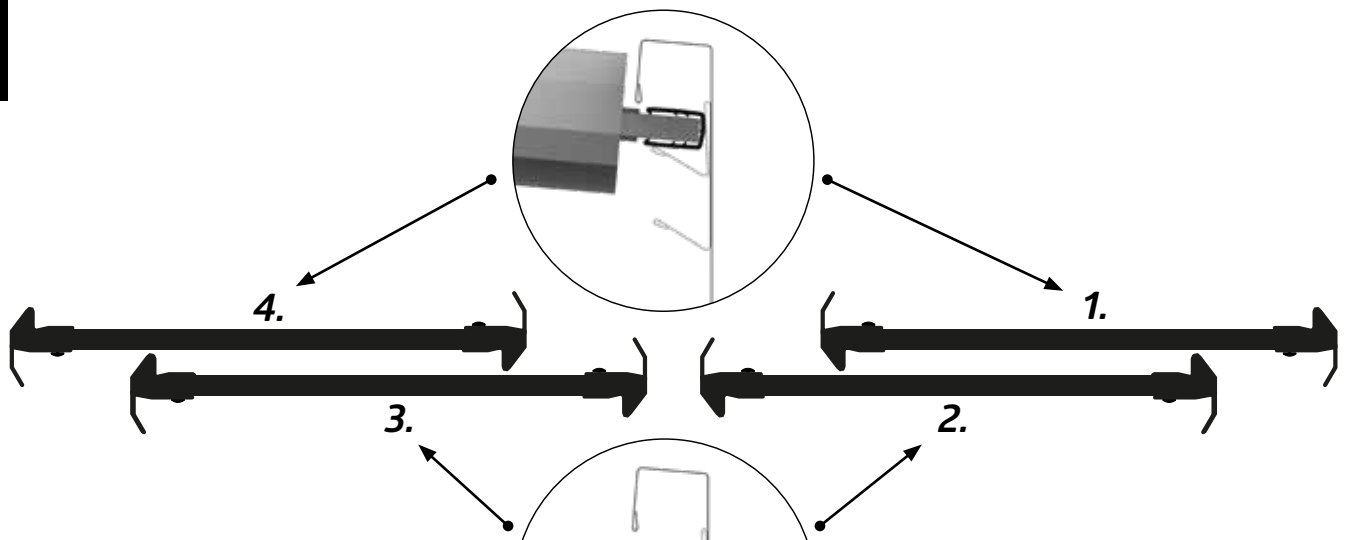

5.

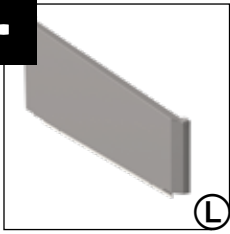

1x

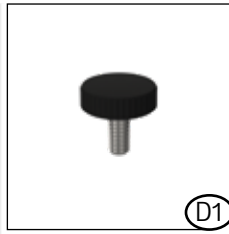

2x

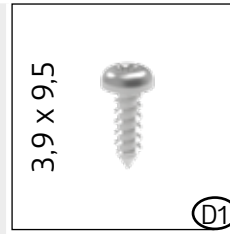

2x

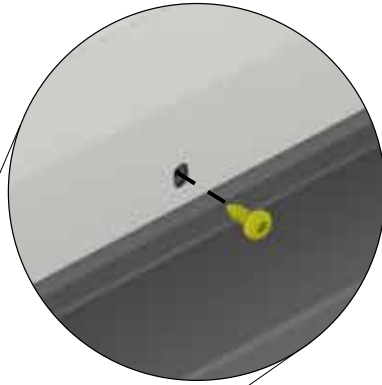
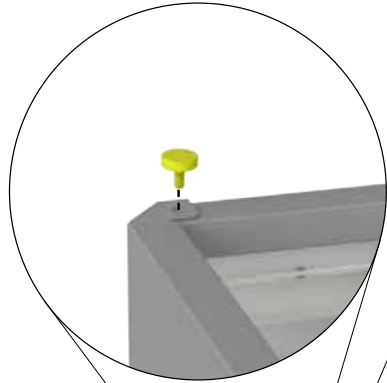

FESTZIEHEN

- Ⓔ tighten
- Ⓕ serrez fort
- Ⓖ vastdraaien
- Ⓔ apriete
- Ⓘ serrare a fondo
- Ⓓ fastspænding
- Ⓔ Dra åt
- Ⓔ Stramme
- Ⓖ Dokręcić
- Ⓔ Dotiahnuť
- Ⓔ Zategnite
- Ⓔ Dotáhnout
- Ⓔ Erősen meghúzni
- Ⓔ Zategnite
- Ⓔ Strangeti

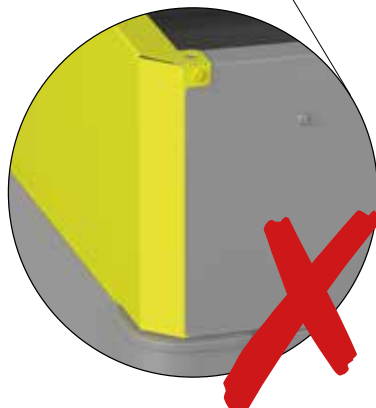
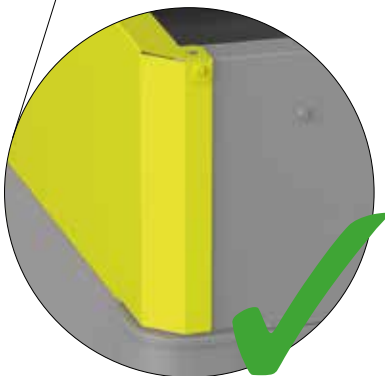
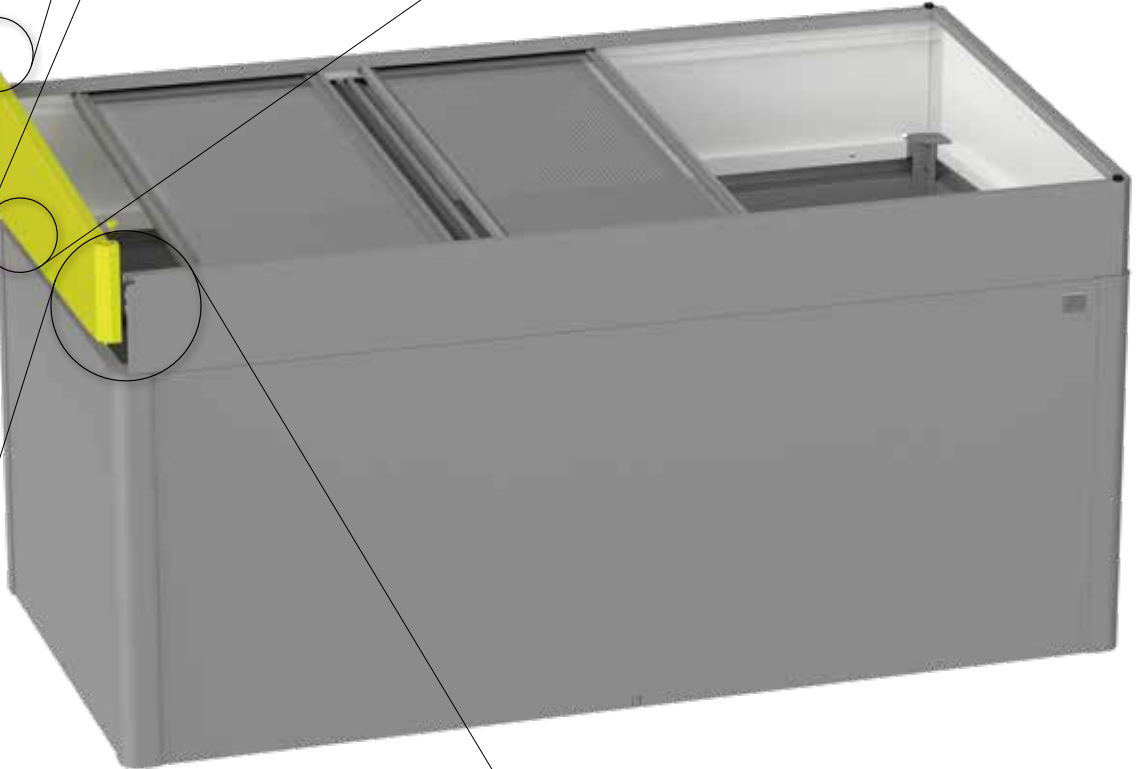

Gerätehäuser
Garden Sheds



Geräteschränke
Outdoor Lockers



Gartenboxen & Multitalente
Outdoor Boxes & Multi-Functional Storage



Outdoor Living
Outdoor Living



Gewächshäuser
Greenhouses



Pflanzbeete
Planting Beds



Gartenhelfer
Gardening Helpers



follow us:

- 📷 biohort
- 📘 biohort
- 📺 Biohort GmbH
- 📌 Biohort GmbH



Adresses sur quefairedemesdechets.fr

Biohort GmbH
PürNSTein 43, 4120
Neufelden, Österreich
+43 7282 / 7788 0
office@biohort.at
www.biohort.com