

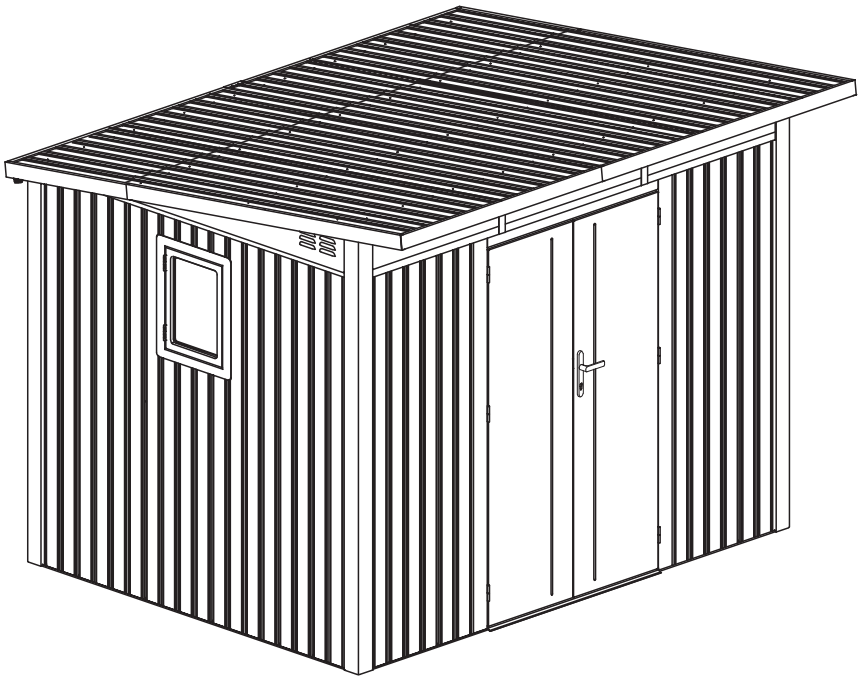

Manual

Garden house G21

Madison 731



EN DE CZ SK HU PL HR SLO

۲۱

EN

Thank you for purchasing our product.

Before using this unit, please read this manual.

Assembly instructions:

Prior to the assembly please read all instructions and information carefully. The garden house has to be anchored to its base in order to prevent damage. The base is not included in the delivery and it has to be built separately.

Check whether you have all parts which are necessary for the assembly.

Please mind your own safety.

1. 2-3 persons are required for the assembly of this garden house.
2. Use protective clothing and gloves as some parts might be sharp.
3. During the assembly no children or pets should be present in the working area.
4. Do not stand on the roof with all your weight.

Care and maintenance:

1. Clean the house using cloth and water
2. Keep the rails of the sliding door clean and free of any objects that might restrain the door's fluent movement.
3. In case of snowfall remove the snow from the roof regularly.
4. The house is not designed for living but only for storage purposes.

The English version of the manual is an exact translation of the original manufacturer's instructions.

Images used in this manual are for illustrational purposes only and may differ from the actual product.

DE

Vielen Dank für den Kauf unseres Produktes.

Bevor Sie dieses Gerät verwenden, lesen Sie diese Anleitung.

Montageanleitung:

Vor der Montage lesen Sie bitte alle Anweisungen und Angaben vorsichtig. Das Gartenhaus muss auf dem Fundament verankert sein um eine Beschädigung zu verhindern. Das Fundament ist nicht im Lieferumfang enthalten und muss separat angelegt werden.

Überprüfen Sie, ob alle Teile, die für die Montage notwendig sind, vorhanden sind.

Bitte beachten Sie zu Ihrer eigenen Sicherheit.

1. Für die Montage dieses Gartenhauses sind 2-3 Personen erforderlich.
2. Tragen Sie Schutzkleidung und Arbeitshandschuhe, da einige Teile scharfe Kanten haben können.
3. Während des Zusammenbaus sollten sich keine Kinder oder Tiere im Arbeitsbereich aufhalten.
4. Sie sollten sich nicht mit ihrem vollen Gewicht auf das Dach stellen.

Wartung und Pflege:

1. Reinigen Sie das Haus mit Putzlappen und Wasser.
2. Halten Sie die Schienen der Schiebetür sauber und frei von jeglichen Gegenständen, die möglicherweise eine flüssige Bewegung der Tür behindern könnten.
3. Bei Schneefall entfernen Sie regelmäßig den Schnee vom Dach.
4. Das Haus ist nicht geeignet um darin zu wohnen, sondern nur zu Lagerzwecken konzipiert.

Die deutsche Version der Anleitung ist eine genaue Übersetzung der Anleitung des Herstellers.

Die in diesem Handbuch verwendeten Bilder dienen nur zur Illustration und können nicht genau das Produkt entsprechen.



Děkujeme za nákup našeho výrobku.

Před použitím si prosím přečtete tento návod.

Montážní návod:

Dříve, než začnete s montáží, pečlivě si prostudujte všechny pokyny a informace. Domek musí být řádně ukotven k základové desce, aby nedošlo při silném větru k jeho poškození nebo zničení. Základna není součástí balení, je nutné si ji vybudovat samostatně.

Zkontrolujte, zda máte všechny potřebné díly pro stavbu domku.

Dbejte na svoji bezpečnost.

1. Domek montujte ve 2-3 lidech.
2. Při montáži používejte ochranný oděv a rukavice, protože některé části mohou být ostré.
3. V době montáže by se po staveništi neměly pohybovat děti a domácí zvířata.
4. Nikdy nestůjte na střeše celou svou vahou.

Péče a údržba:

1. Domek čistěte za pomoci hadru a vody.
2. Uchovávejte kolejničky posuvu dveří v čistotě, odstraňte předměty, které brání jejich snadnému klouzání.
3. V případě sněžení pravidelně odklízejte ze střechy domku napadaný sníh.
4. Domek není určen pro bydlení, ale pro ukládání věcí.

Česká verze návodu je přesným překladem originálního návodu výrobce.

Fotografie použité v manuálu jsou pouze ilustrační a nemusí se přesně shodovat s výrobkem.



Ďakujeme za nákup nášho výrobku.

Pred použitím si prosím prečítajte tento návod.

Návod na montáž:

Pred montážou si pozorne prečítajte všetky pokyny a informácie. Domček musí byť riadne ukotvený k základnej doske, aby pri silnom vetre nedošlo k jeho poškodeniu alebo zničeniu. Základňa nie je súčasťou balenia, je nutné ju vybudovať samostatne.

Skontrolujte, či máte všetky potrebné diely na stavbu domčeka.

Dbajte na svoju bezpečnosť.

1. Na montáž domčeka sú potrebné 2-3 osoby.
2. Pri montáži používajte ochranný odev a rukavice, pretože niektoré časti môžu byť ostré.
3. Počas montáže by sa v pracovnom prostredí nemali pohybovať deti ani domáce zvieratá.
4. Nikdy nestojte na streche celou svojou váhou.

Starostlivosť a údržba:

1. Domček čistite pomocou handry a vody.
2. Uchovávať kolejničky posuvu dverí čisté a odstraňujte všetky predmety, ktoré by bránili jednoduchému posuvu.
3. V prípade sneženia pravidelne zo strechy domčeka odstraňujte napadaný sneh.
4. Domček nie je určený na bývanie, ale výhradne na ukladanie vecí.

Slovenská verzia návodu je presným prekladom originálneho návodu výrobcu.

Fotografie použité v návode sú len ilustračné a nemusia sa presne zhodovať s výrobkom.



Köszönjük, hogy megvásárolta termékünket.

Használat előtt kérjük olvassa el a használati útmutatót.

Telepítési útmutató:

Telepítés előtt figyelmesen olvassa el az összes utasítást és információt. A házat szilárdan és stabilan, egy alapra kell rögzíteni, hogy az erős szélben ne mozduljon el, vagy esetleg ne menjen tönkre. Az alapot a csomag nem tartalmazza, ezt egyénileg kell biztosítani. Az összeszerelés előtt ellenőrizze, hogy megvan-e minden alkatrész.

Ügyeljen a biztonságra.

1. A ház összeszereléséhez legalább 2-3 ember kell.
2. Telepítés közben vegyen fel védőöltözetet és kesztyűt, mert néhány alkatrész éles lehet.
3. A szerelés közben ne legyenek se gyermek, se háziállat ne tartózkodjon a közelben.
4. Soha ne nehezedjen a tetőre teljes súllyal.

Ápolás és karbantartás:

1. A házat ronggyal és vízzel tisztítsa.
2. A tolóajtó síneit mindig tartsa tisztán és távolítsa el azon tárgyakat, melyek akadályozhatják a gördülést.
3. Havazás esetén mindig söpörje le a havat a tetőről.
4. A ház nem alkalmas lakhatásra, csupán eszközök tárolására.

A magyar használati utasítás a gyártótól kapott verzió pontos fordítása.

A kézikönyvben használt fényképek csak illusztrációk, nem egyeznek meg pontosan a termékkel.



Dziękujemy za zakup naszego produktu.

Przed użyciem prosimy starannie przeczytać tę instrukcję.

Instrukcja montażu:

Przed przystąpieniem do montażu należy dokładnie zapoznać się z zaleceniami i informacjami. Domek musi być prawidłowo umocowany do płyty fundamentowej, aby przy silnym wietrze nie doszło do jego uszkodzenia lub zniszczenia.

Płyta fundamentowa nie stanowi elementu wyposażenia, należy ją wykonać we własnym zakresie.

Należy sprawdzić kompletność wszystkich elementów niezbędnych do budowy domku.

Należy zadbać o własne bezpieczeństwo.

1. Domek powinien być montowany przez ekipę składającą się z 2-3 pracowników.
2. Podczas prac montażowych należy korzystać z odzieży ochronnej i rękawic dlatego, że niektóre z części mogą mieć ostre krawędzie.
3. Podczas prac montażowych na placu budowy niepożądana jest obecność dzieci i zwierząt domowych.
4. Nigdy nie należy całą swoją wagą stać na dachu domku.

Pielęgnacja i konserwacja:

1. Do czyszczenia domku używać ścierki i wody.
2. Należy dbać o utrzymanie w czystości szyn do przesuwu drzwi, usuwać przedmioty hamujące przesuwanie drzwi.
3. W razie opadów śniegu, z dachu domku należy usuwać zalegający śnieg.
4. Domek nie jest przeznaczony do zamieszkania lecz tylko do przechowywania i składowania przedmiotów.

Polska wersja językowa instrukcji jest dokładnym tłumaczeniem oryginalnej instrukcji producenta.

Zdjęcia wykorzystane w tym podręczniku są jedynie ilustracją i nie może dokładnie dopasować produkt.

Hvala vam na kupnji našeg proizvoda.

Molimo pročitajte ovaj priručnik prije upotrebe.

Upute za montažu:

Prije početka montaže pažljivo pročitajte sve upute i informacije. Kućica mora biti pravilno pričvršćena za temeljnu ploču kako bi se spriječilo oštećenje ili uništenje uslijed jakog vjetrova. Podnožje nije uključeno u pakiranje, mora se zasebno izgraditi.

Provjerite imate li sve potrebne dijelove za izgradnju kuće.

Vodite računa o svojoj sigurnosti.

1. Kućicu sastavljaju 2-3 osobe.
2. Tijekom montaže nosite zaštitnu odjeću i rukavice jer neki dijelovi mogu biti oštri.
3. Djeca i kućni ljubimci ne smiju biti na gradilištu tijekom montaže.
4. Nikada ne stojte na krovu punom težinom.

Njega i održavanje:

1. Kućicu čistite krpom i vodom.
2. Klizne vodilice vrata održavajte čistima, uklonite predmete koji sprječavaju njihovo lako klizanje.
3. U slučaju snježnih padalina redovito uklanjajte snijeg s krova kuće.
4. Kućica nije namijenjena za stanovanje, već za pohranu stvari.

Hrvatska verzija priručnika točan je prijevod originalnih uputa proizvođača.

Slike korištene u ovom priručniku služe samo za ilustraciju i mogu se razlikovati od stvarnog proizvoda.

Hvala za nakup našega izdelka.

Pred uporabo preberite ta priročnik.

Navodila za montažo:

Pred začetkom montaže natančno preberite vsa navodila in informacije. Hiša mora biti pravilno pritrjena na osnovno ploščo, da preprečite poškodbe ali uničenje v močnem vetru. Podstavek ni vključen v paket, zgraditi ga je treba ločeno.

Preverite, ali imate vse potrebne dele za gradnjo hiše.

Poskrbite za svojo varnost.

1. Hišo sestavljajo 2–3 osebe.
2. Med montažo nosite zaščitna oblačila in rokavice, saj so nekateri deli lahko ostri.
3. Otroci in hišni ljubljenci med montažo ne smejo biti na gradbišču.
4. Nikoli ne stojte na strehi s polno težo.

Nega in vzdrževanje:

1. Hišo čistite s krpo in vodo.
2. Drsnice tirnice vrat vzdržujte čiste, odstranite predmete, ki preprečujejo njihovo enostavno drsenje.
3. V primeru sneženja redno odstranjujte sneg s strehe hiše.
4. Hiša ni namenjena bivanju, temveč shranjevanju stvari.

Slovenska različica navodil za uporabo je natančen prevod originalnih proizvajalčevih navodil.

Fotografije, uporabljene v navodilih, so samo ilustrativne in se morda ne ujemajo popolnoma z izdelkom.



EN Installation

DE Montage

CZ Montáž

SK Montáž

HU Összeszerelés

PL Montaż

HR Sastavljanje

SLO Montáž

EN Parts list

DE Teilleiste

CZ Seznam dílů













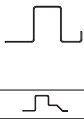









SK Zoznam dielov































HU Alkatrész lista

PL Wykaz części

HR Popis dijelova

SLO Seznam delov

#		mm	PCS
Ana-C1		1458	x1
Ana-C1a		1245	x1
Ana-C2		1371.5	x1
Ana-C2a		1331.5	x1
Ana-B3		2064	x2
Ana-A4			1130
Ac-A5		1900	x2
Anx-A5		2152	x1
Anx-A5a		2152	x1
Ac-A6		1900	x11
Ac-A7		1900	x1
Ana-C9		1521.5	x1
Ana-C9a		1191.5	x1
Ana-B10		2063	x2
Ana-C11		783.5	x2
Ac-C12		1531.5	x1
Ac-C12a		1181.5	x1
Ana-C13		1521.5	x1
Ana-C13a		1191.5	x1
Anx-B14		2063	x2
Ana-A16			1900
Ana-A16a	1900		x1
Ana-A17		1087.5	x1
Ana-C18		904.5	x2
Ana-C18a		1811.5	x2
Ac-C18		1299.5	x1
Ac-C18a		1299.5	x1
Anx-B20		2019	x2
Ana-C21		190	x1
Anx-B21		1999	x1
Anx-B21a		1999	x1
Anx-B22		161	x2
Anx-B22a		81	x2
Ana-C22		223	x2
Ana-A22a		223	x2
Anx-C22		70	x1
Anx-C23		2079.5	x2
Anx-C23a		737	x2
Anx-D23		1812	x1
Anx-D23a		903	x1
Ana-C36		890	x3
Ana-C33		272	x2

#		mm	PCS
Ac-A29		1804	x1
Ac-A29a		1804	x1
Anx-B24		1823.5	x1
Anx-B24a		785	x1
Anx-B25		1823.5	x3
Anx-B25a		1823.5	x1
Anx-B25b		785	x3
Anx-B25c	785	x1	
Anx-A27		1296.9	x1
Anx-C27a		1616.4	x1
Anx-B28		1760	x2
Anx-B28a		794	x1
Anx-B28b		794	x1
Anx-C26		1447	x1
Anx-C26a		1447	x1
Ana-P1			x2
Anx-26		90	x1
Ab-4			x12
Anx-C37			5.3M
Ana-P6			x1
Ana-P7			x1
Ana-P8			x1
Ab-50			x6
Ana-54			x1
Ana-55			x1
Ana-56			x1
Ana-57			x1
Ana-58		M5x45	x3
Anx-C40			x216
Anx-C41		ST4x10	x351
Ana-A42		ST4x10	x2
Anx-C42		M6x12	x2
Anx-A43		M4x10	x18
Anx-A44		M5x8	x4
Anx-C45		ST4x25	x17
Anx-C46		M4x10	x17
Anx-C47		ST4x16	x4
Anx-C48		M6x25	x6

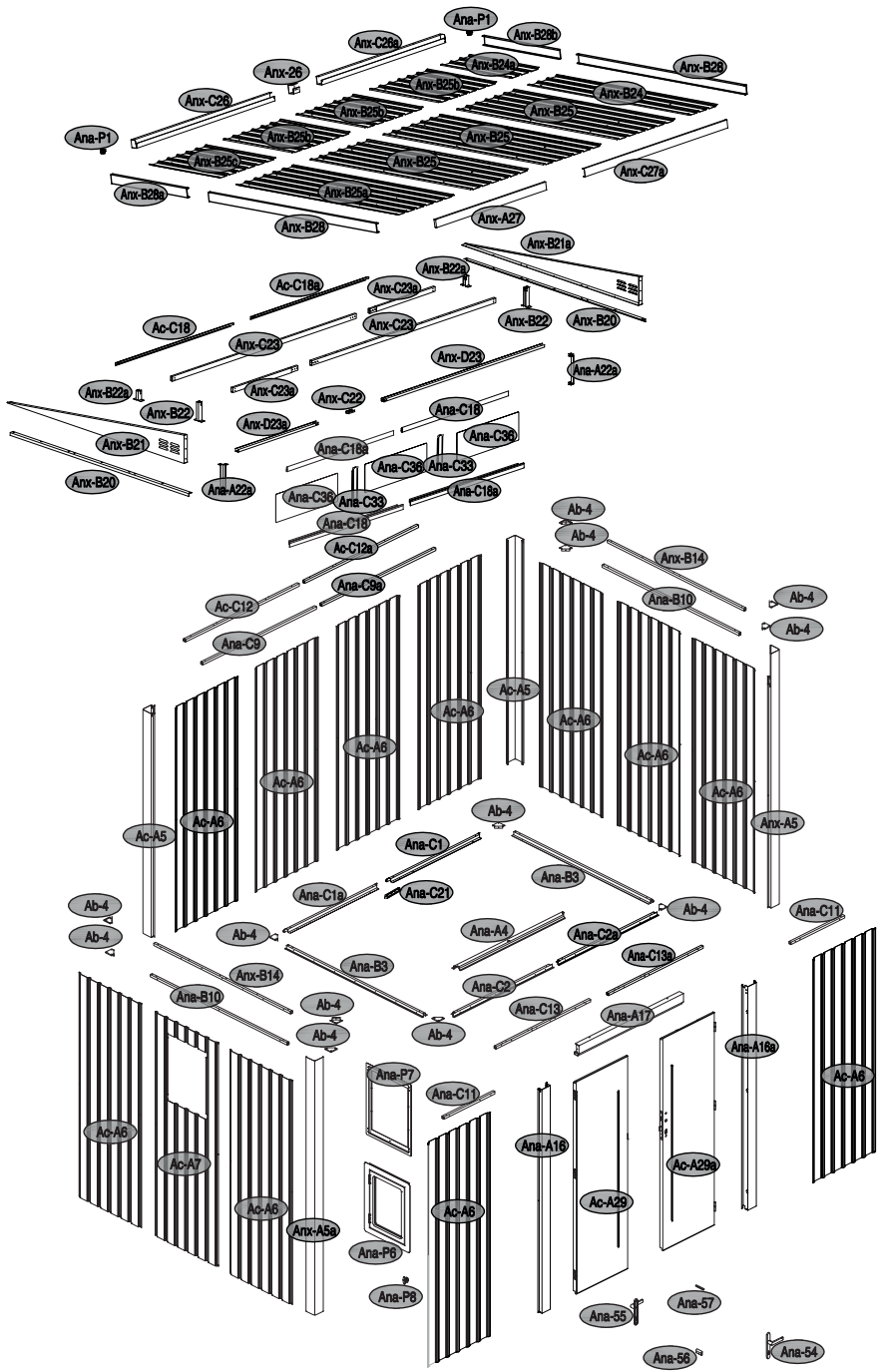

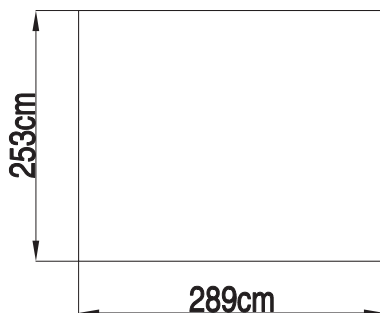
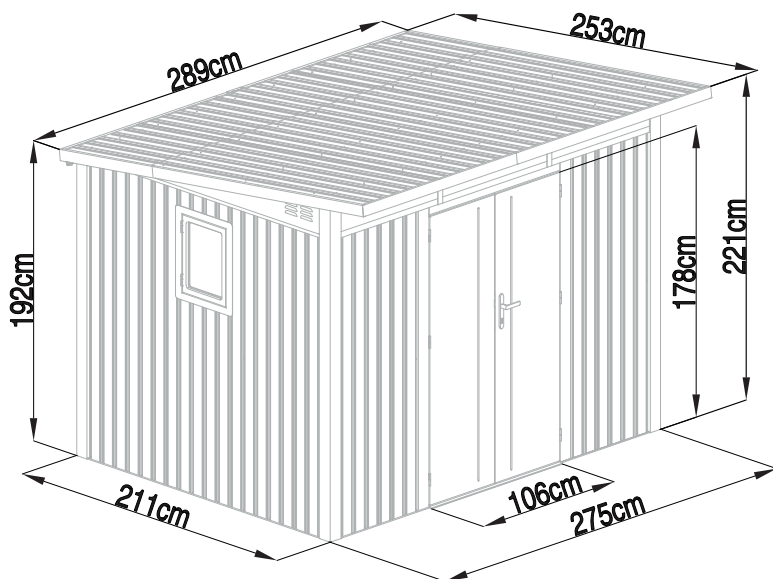
EN Dimensions**DE** Abmessungen**CZ** Rozměry**SK** Rozmery**HU** Méretek**PL** Wymiary**HR** Dimenzije**SL** Dimenzije

EN Tools you will need

CZ Nástroje, které budete potřebovat

HU Szükséges eszközök és szerszámok

HR Alati koji će vam trebati

DE Werkzeuge, die Sie brauchen

SK Nástroje, ktoré budete potrebovať

PL Przyrządy i narzędzia, które będą potrzebne

SL Orodja, ki jih boste potrebovali

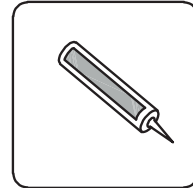
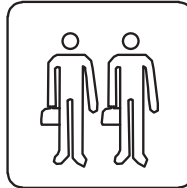
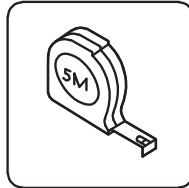
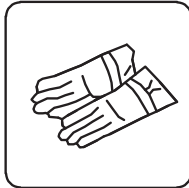
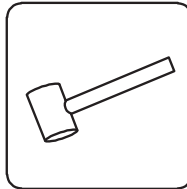
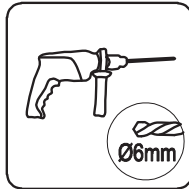
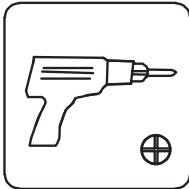

EN Assembly instructions

DE Montageanleitung

CZ Návod k montáži

SK Návod k montáži

HU Szerelési útmutató

PL Instrukcja montażu

HR Upute za montažu

SLO Navodila za namestitev

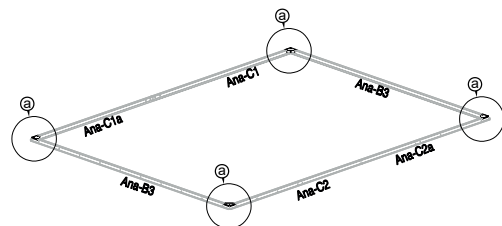
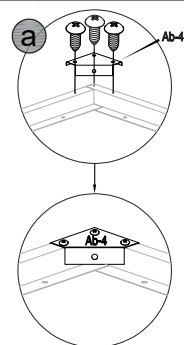
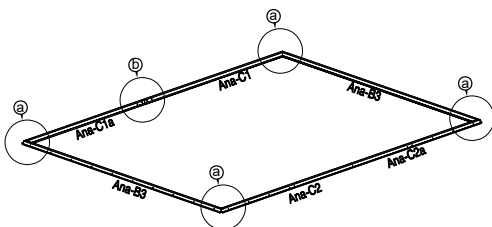
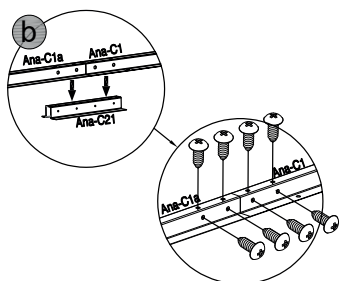
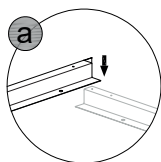

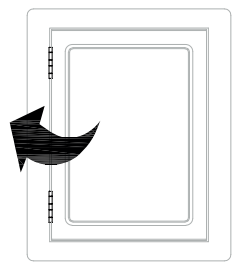



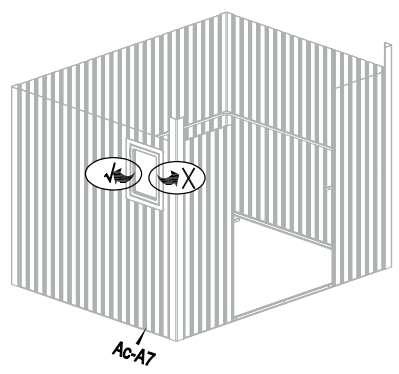
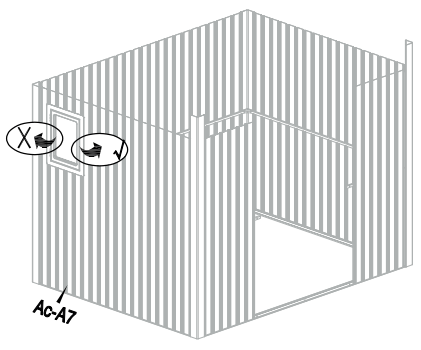
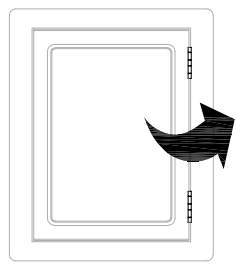

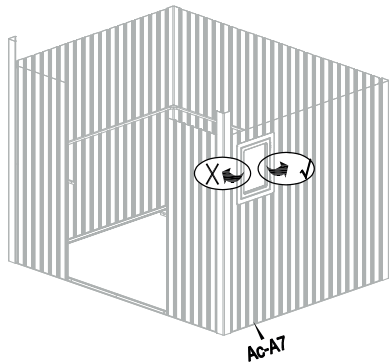
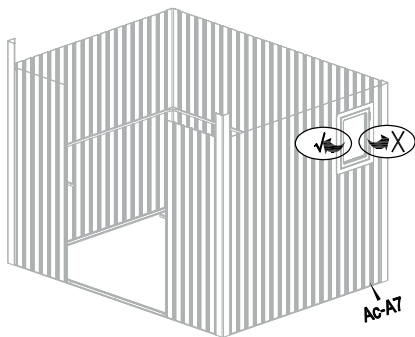
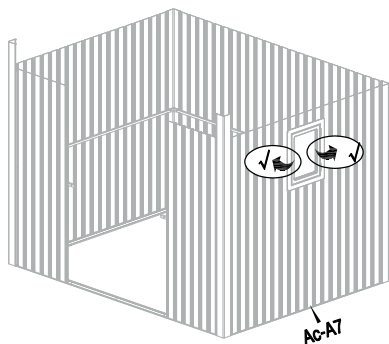
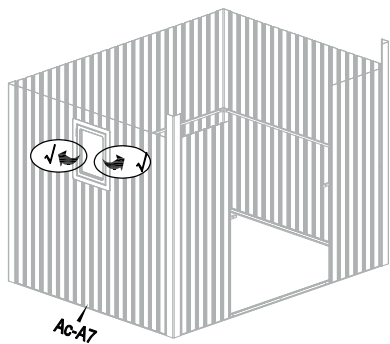

Or



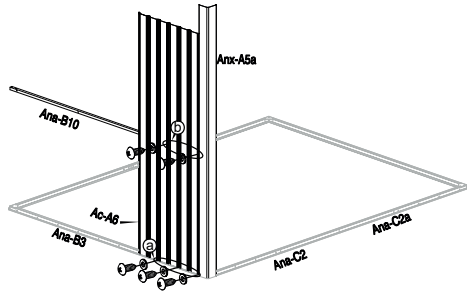
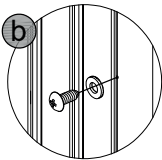
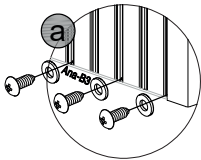
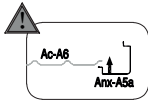

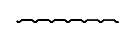
3	 Ac-A6 x1	 Anx-A5a x1	 Ana-B10 x1	 Anx-C41 x5	 Anx-C40 x5	
----------	---	---	---	---	---	--



4	 Ac-A6 x1	 Ana-C11 x1	 Anx-C41 x5	 Anx-C40 x5	
----------	---	---	---	---	--

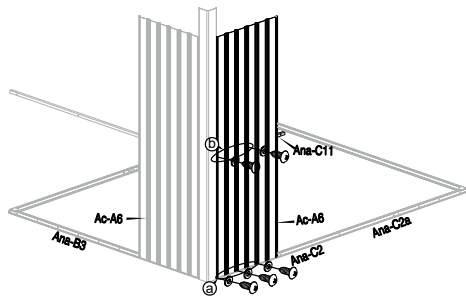
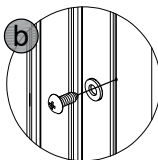
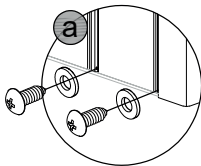





4

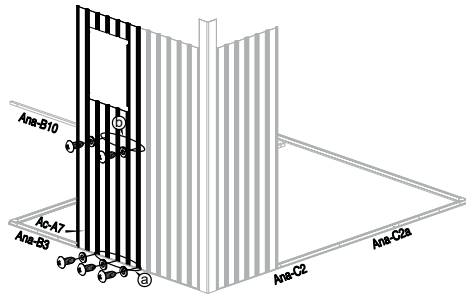
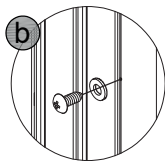
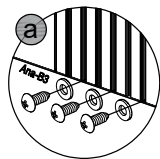





5	 Ac-A7 x1	 Anix-C41 x5	 Anix-C40 x5	
----------	---	--	--	--

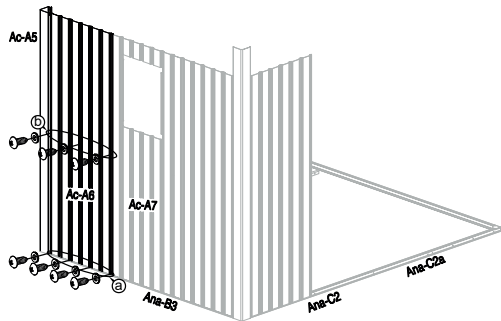
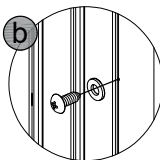
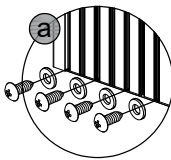





6	 Ac-A6 x1	 Ac-A5 x1	 Anix-C41 x7	 Anix-C40 x7	
----------	---	---	--	--	--

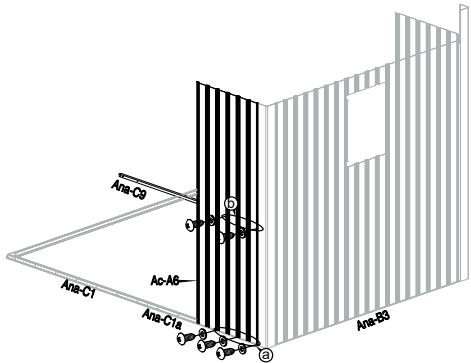
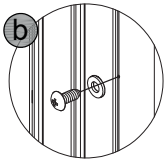
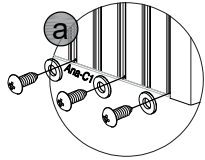

7	 Ac-AB x1	 Ana-C9 x1	 Anx-C41 x5	 Anx-C40 x5	
----------	---	--	---	---	--





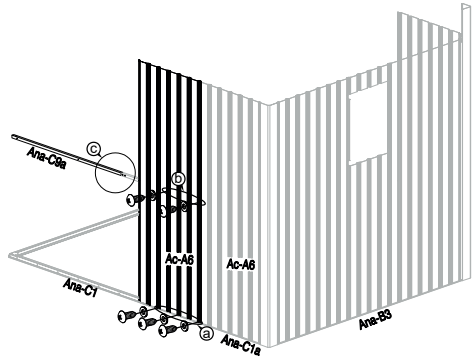
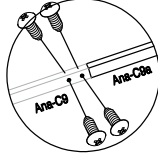
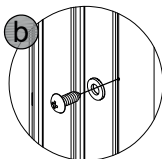
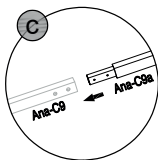
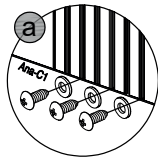

8	 Ac-AB x1	 Ana-C9a x1	 Anx-C41 x9	 Anx-C40 x5	
----------	---	---	---	---	--

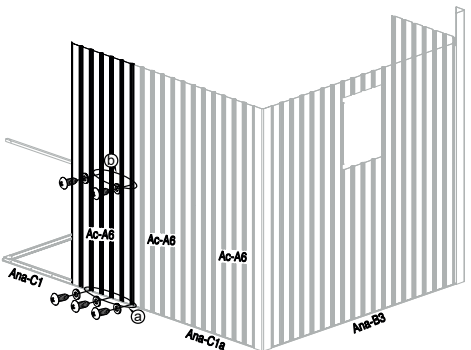
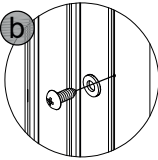
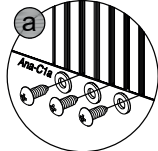





9	 Ac-A6 x1	 Anix-C41 x5	 Anix-C40 x5	
----------	---	--	--	--

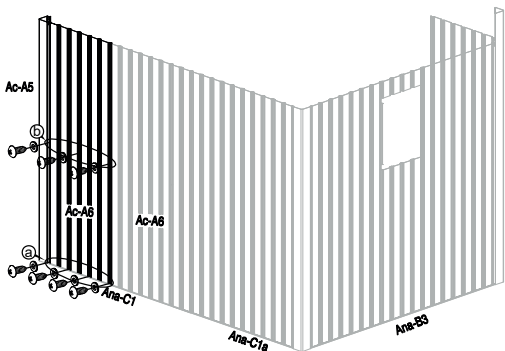
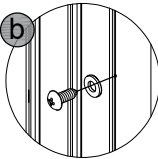
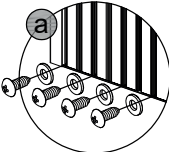

10	 Ac-A6 x1	 Ac-A5 x1	 Anix-C41 x7	 Anix-C40 x7	
-----------	---	---	--	--	--





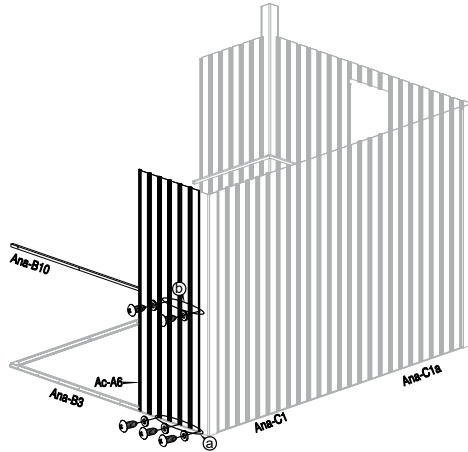
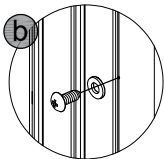
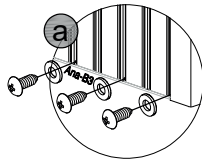

11	 Ac-A6 x1	 Ana-B10 x1	 Anx-C41 x5	 Anx-C40 x5	
----	---	---	---	---	--

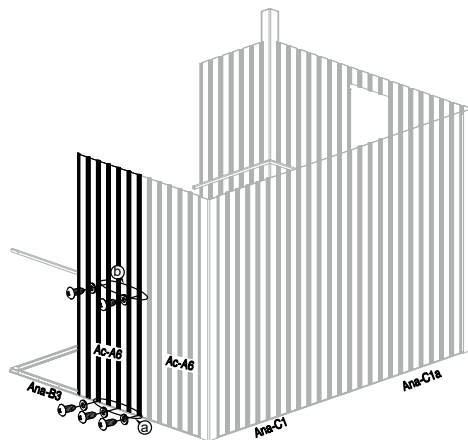
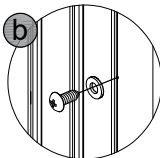
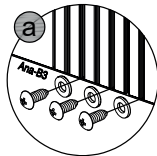

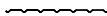



12	 Ac-A6 x1	 Anx-C41 x5	 Anx-C40 x5	
----	---	---	---	--

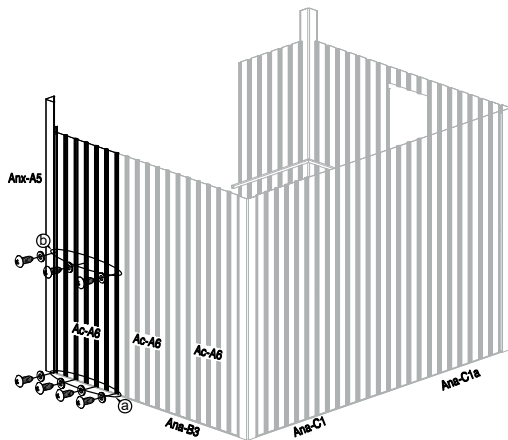
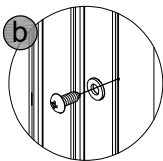
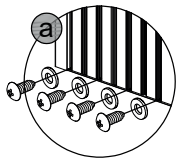

13	 Ac-A6 x1	 Anx-A5 x1	 Anx-C41 x7	 Anx-C40 x7	
-----------	---	--	---	---	--



14	 Ac-A6 x1	 Anx-C11 x1	 Anx-C41 x5	 Anx-C40 x5	
-----------	---	---	---	---	--

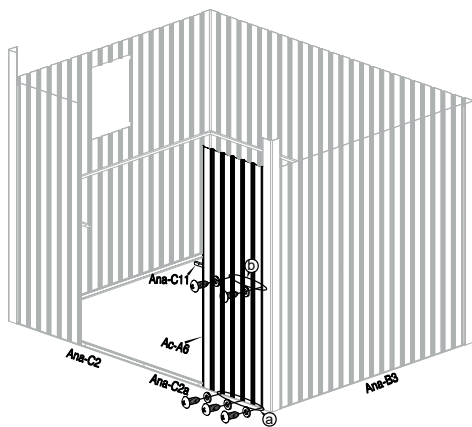
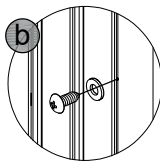
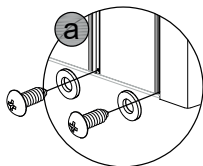

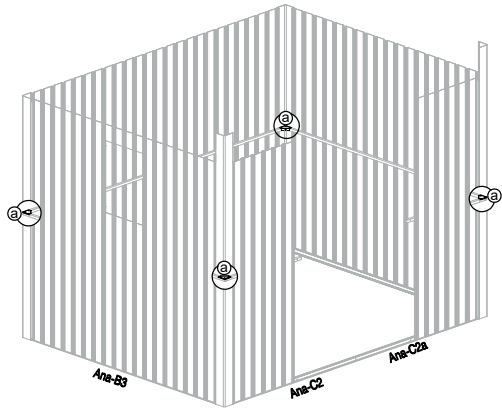
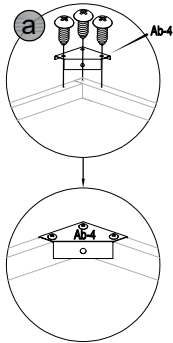

15	 Ab-4 x4	 Anx-C41 x12	
-----------	--	--	--

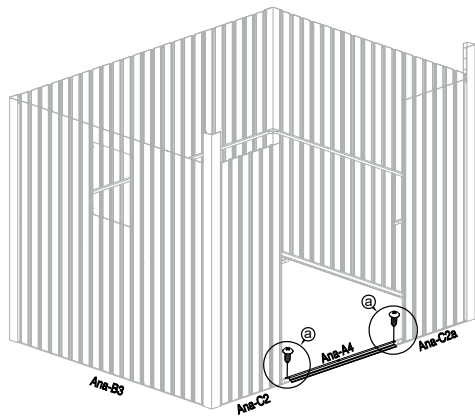
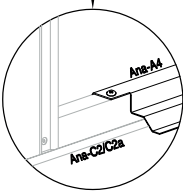
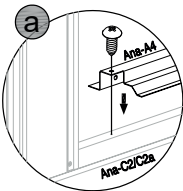
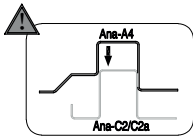

16	 Ana-M4 x1	 Anx-C41 x2	
-----------	--	---	--

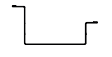
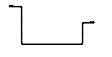



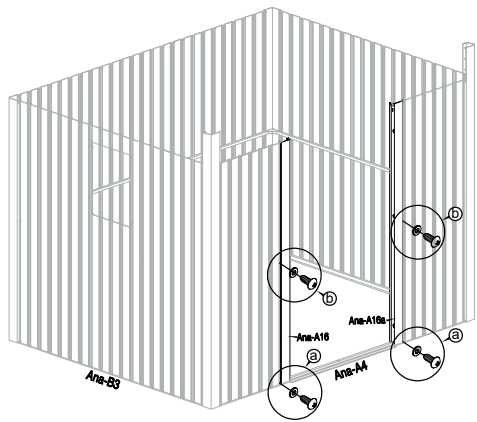
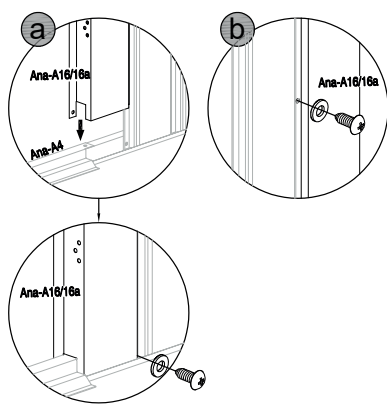

17	 <p>Ana-A16 x1</p>	 <p>Ana-A16a x1</p>	 <p>Anx-C41 x4</p>	 <p>Anx-C40 x4</p>	
----	---	--	---	---	--

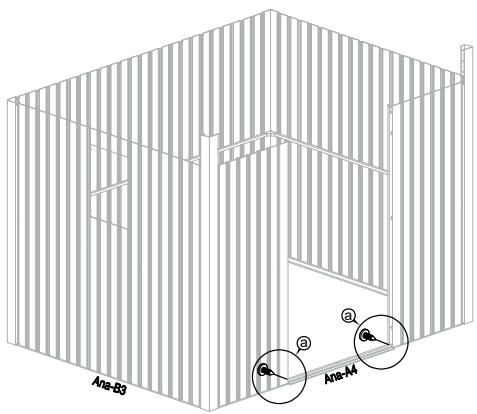
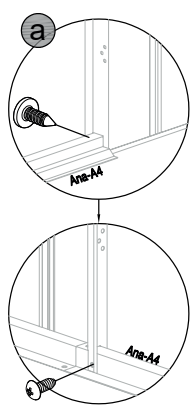





18	 <p>Anx-C41 x2</p>	
----	---	--

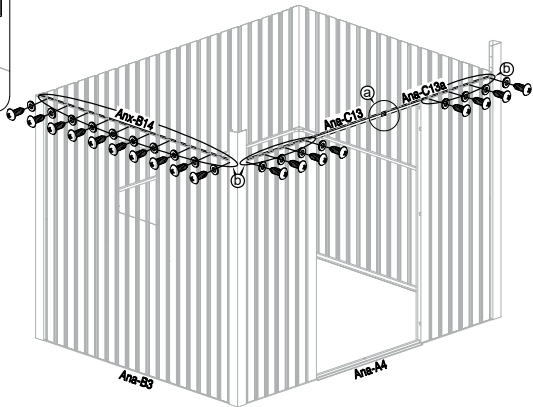
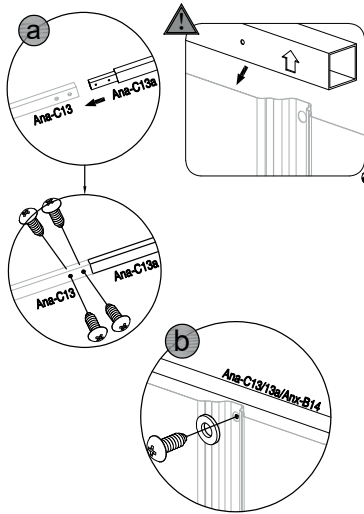

19	 Ana-B14 x1	 Ana-C13 x1	 Ana-C13a x1	 Anx-C41 x22	 Anx-C40 x18	
-----------	---	---	--	--	--	--



20	 Ana-B14 x1	 Ac-C12 x1	 Ac-C12a x1	 Anx-C41 x28	 Anx-C40 x28	
-----------	---	--	---	--	--	--

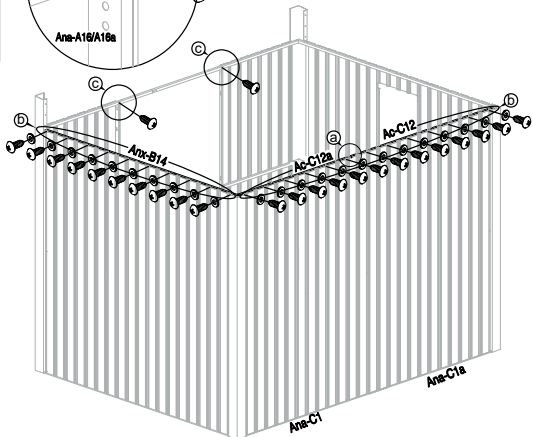
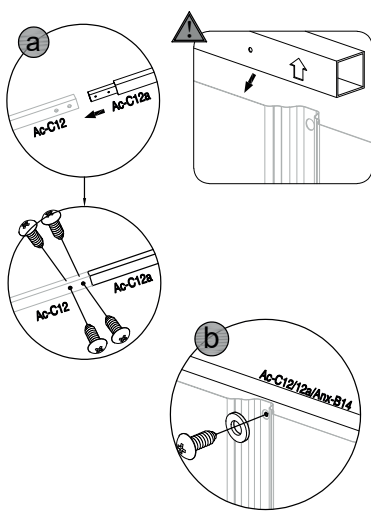



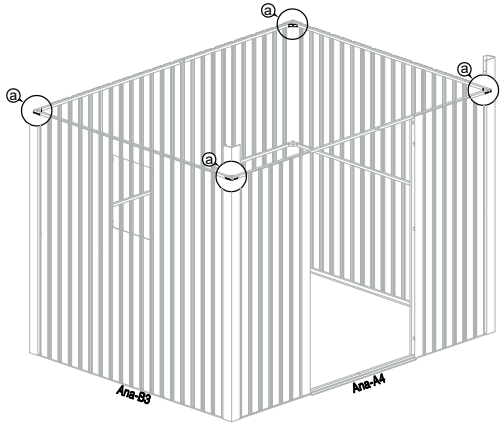
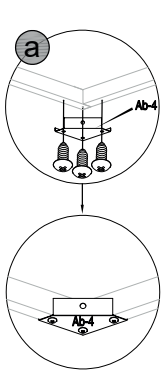

<p>21</p>	 <p>Ab-4 x4</p>	 <p>Anx-C41 x12</p>	
------------------	--	--	--

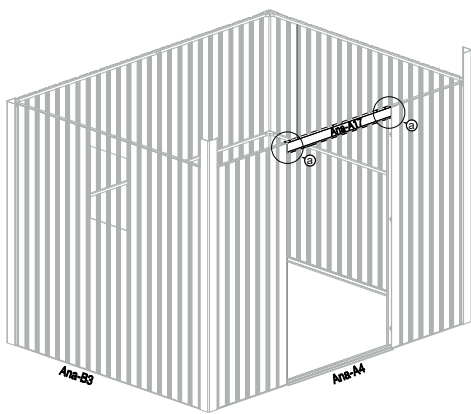
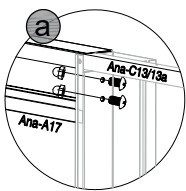
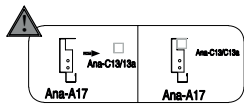





<p>22</p>	 <p>Ana-A17 x1</p>	 <p>Anx-A44 x4</p>	
------------------	---	---	--

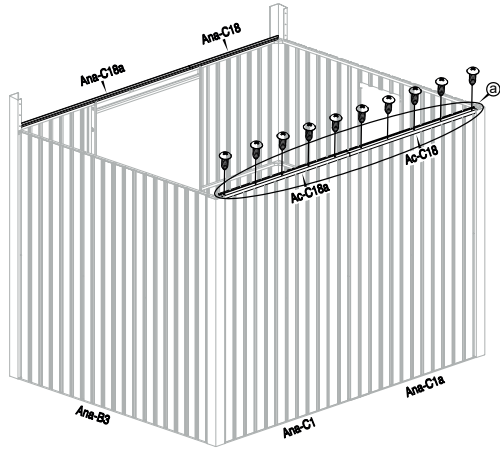
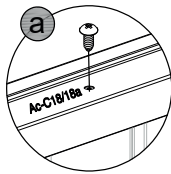
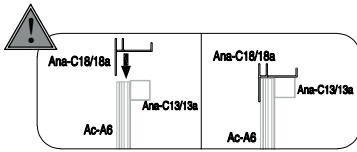





23	 Ana-C18 x1	 Ana-C18a x1	 Ac-C18 x1	 Ac-C18a x1	 Anx-C41 x10
-----------	---	--	--	---	--

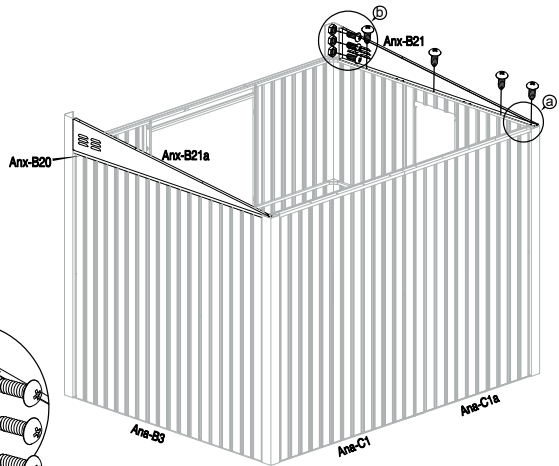
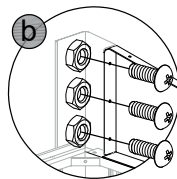
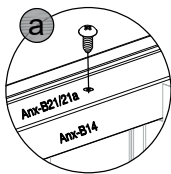
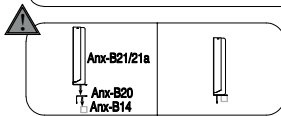
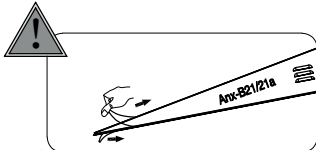

24	 Anx-B21 x1	 Anx-B21a x1	 Anx-B20 x2	 Anx-C41 x8	 Anx-C46 x8
-----------	---	--	---	---	---



<p>25</p>	 <p>Anx-B22 x2</p>	 <p>Anx-B22a x2</p>	 <p>Ana-C22 x2</p>	 <p>Ana-A22a x2</p>	 <p>Anx-C41 x16</p>
-----------	---	--	---	--	--

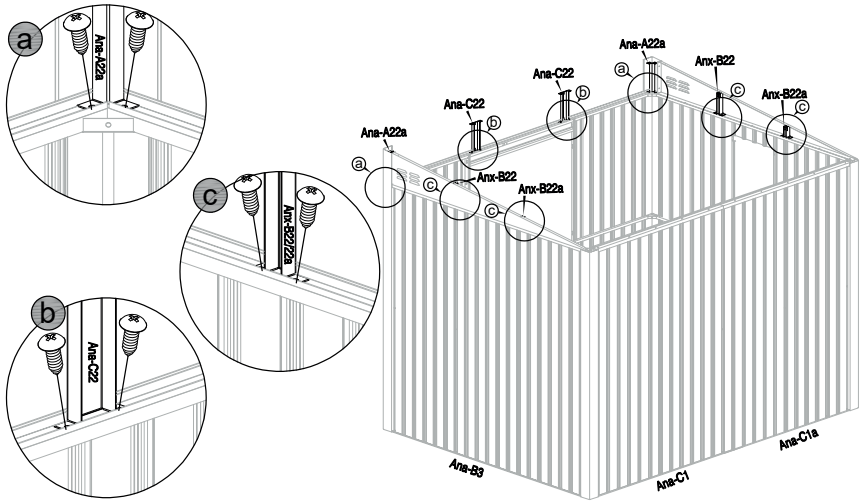



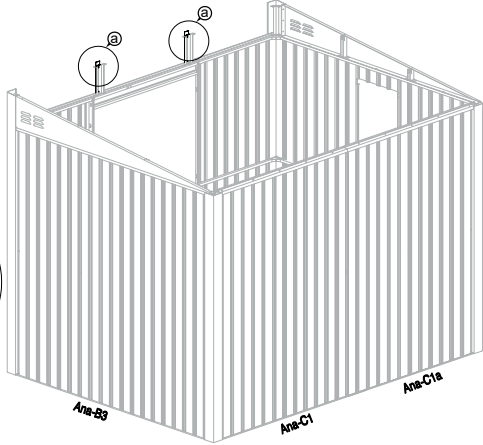
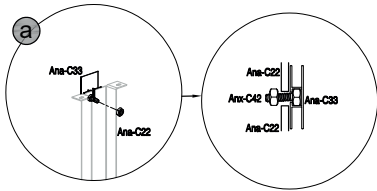
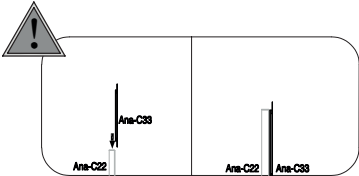

<p>26</p>	 <p>Ana-C33 x2</p>	 <p>Anx-C42 x2</p>	
-----------	---	---	--

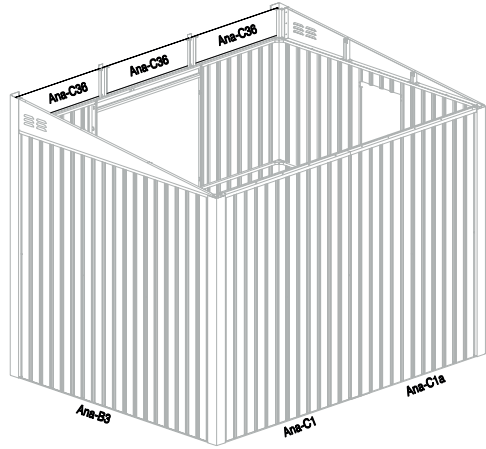
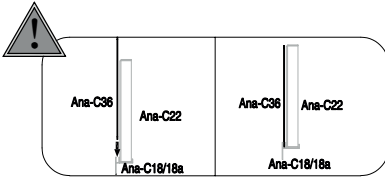
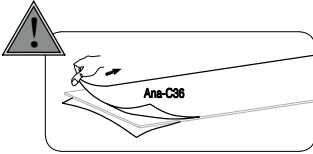

27		
-----------	---	--

Ana-C36 x8



28					
-----------	---	---	---	---	--

Anx-D23 x1

Anx-D23a x1

Anx-C22 x1

Anx-C41 x8

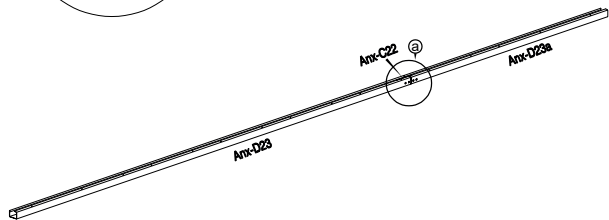
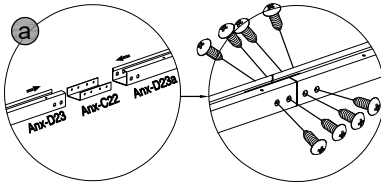

29	 Ana-C18 x1	 Ana-C18a x1	 Anx-C41 x8	
-----------	----------------	-----------------	----------------	--

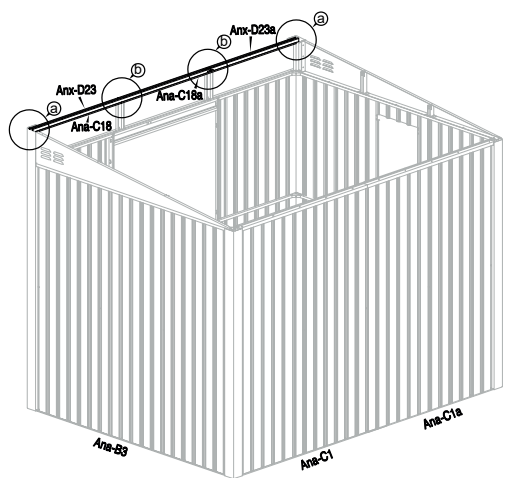
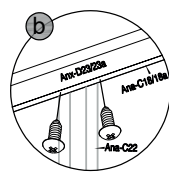
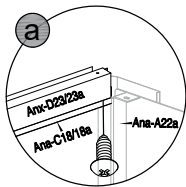
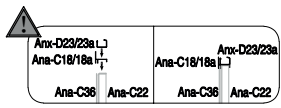

30	 Anx-C23 x2	 Anx-C23a x2	 Anx-C41 x18	 Anx-C48 x8	
-----------	----------------	-----------------	-----------------	----------------	--

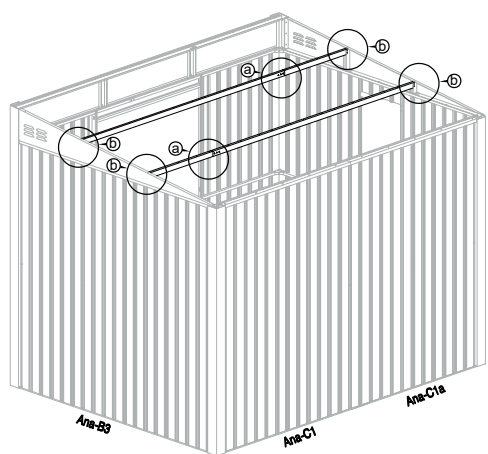
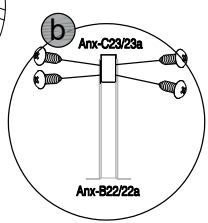
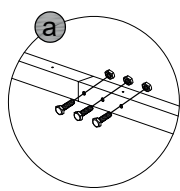
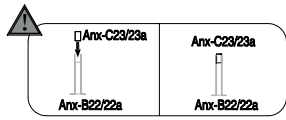

<p>31</p>	 <p>Anx-B25c x1</p>	 <p>Anx-C41 x3</p>	 <p>Anx-C40 x3</p>	
------------------	--	---	---	--

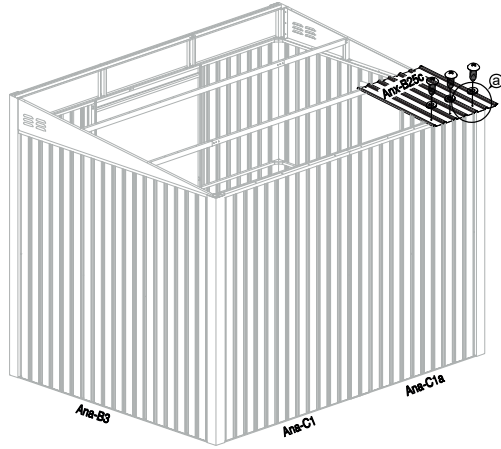
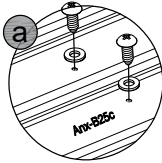



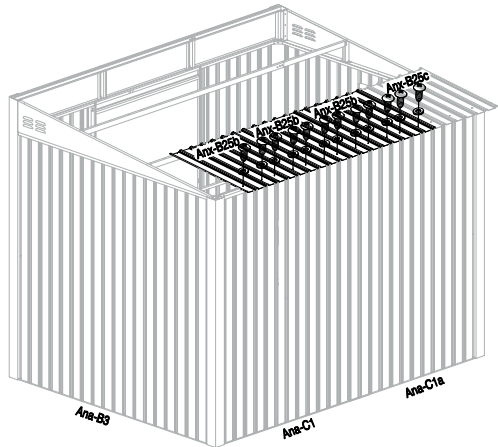
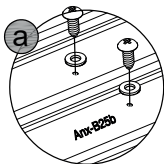
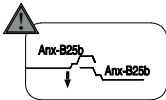
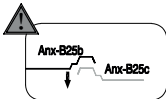

<p>32</p>	 <p>Anx-B25b x3</p>	 <p>Anx-C41 x12</p>	 <p>Anx-C40 x12</p>	
------------------	--	--	--	--

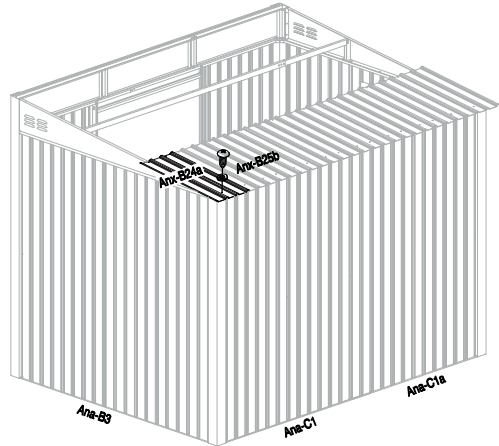
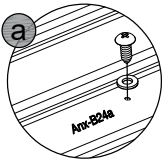
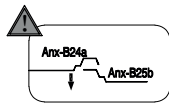

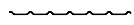



33	 Anrx-B24a x1	 Anrx-C41 x1	 Anrx-C40 x1	
-----------	---	--	--	--

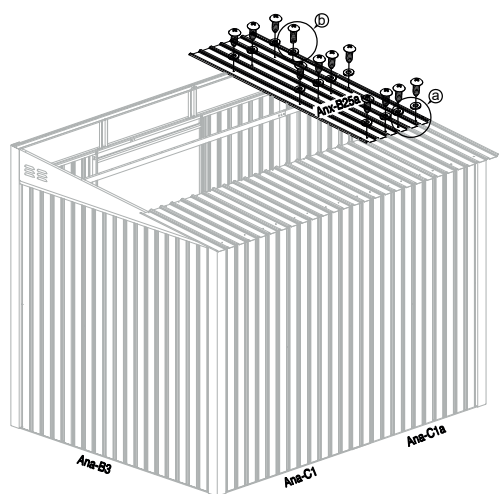
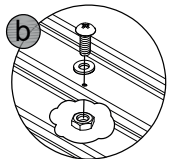
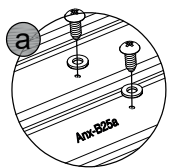

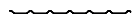
34	 Anrx-B25a x1	 Anrx-C41 x11	 Anrx-C40 x12	 Anrx-C46 x1	
-----------	---	---	---	--	--



35	 Anx-B25 x3	 Anx-C41 x39	 Anx-C40 x12	 Anx-C47 x8
-----------	---	--	--	---

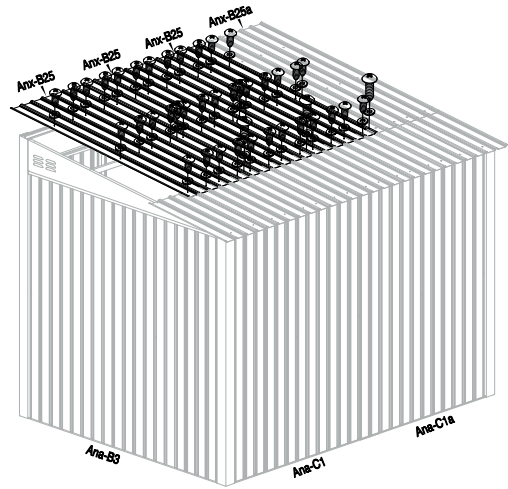
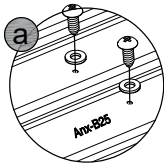
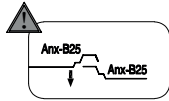
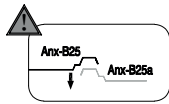

36	 Anx-B24 x1	 Anx-C41 x8	 Anx-C40 x8	 Anx-C46 x1	 Anx-C47 x1
-----------	---	---	---	---	---

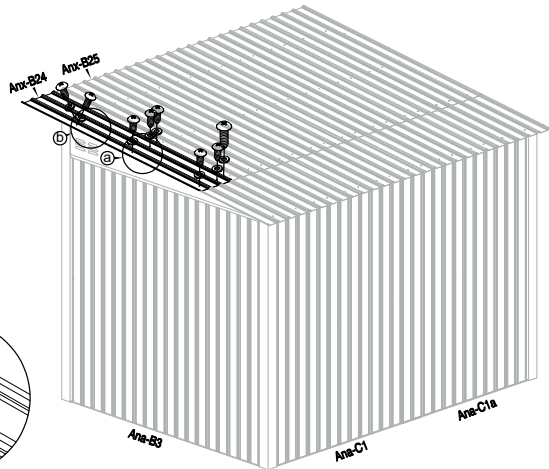
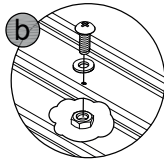
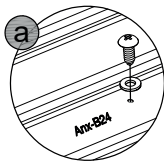
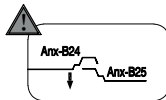

37								
	Anx-A27 x1	Anx-C27a x1	Anx-B28 x2	Anx-B28a x1	Anx-B28b x1	Anx-C41 x10	Anx-C40 x15	Anx-C46 x5

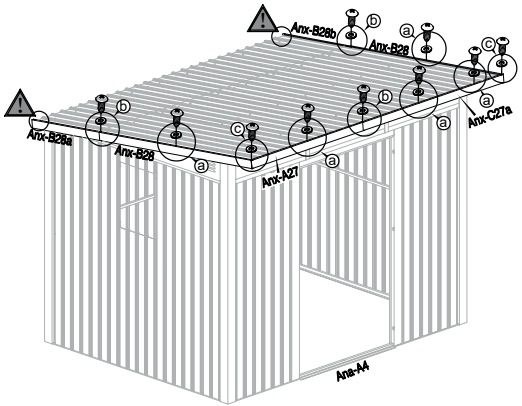
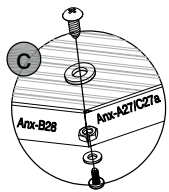
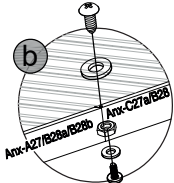
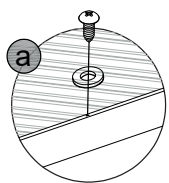
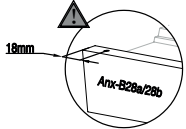
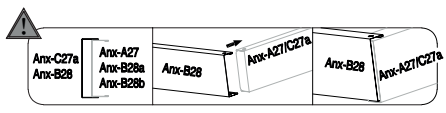

38						
	Anx-C26 x1	Anx-C28a x1	Anx-26 x1	Ana-P1 x2	Anx-C40 x4	Anx-C46 x4

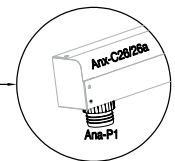
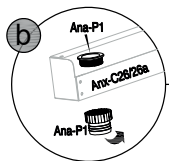
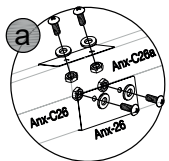
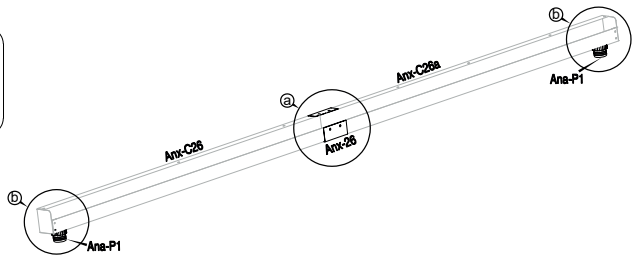
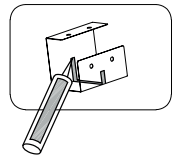



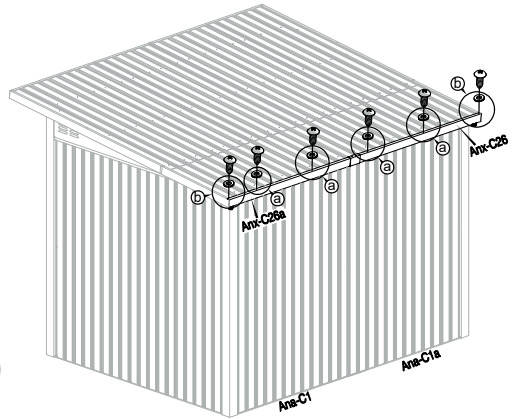
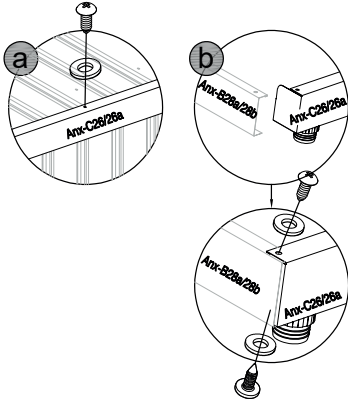
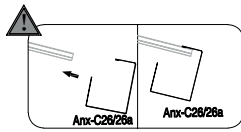

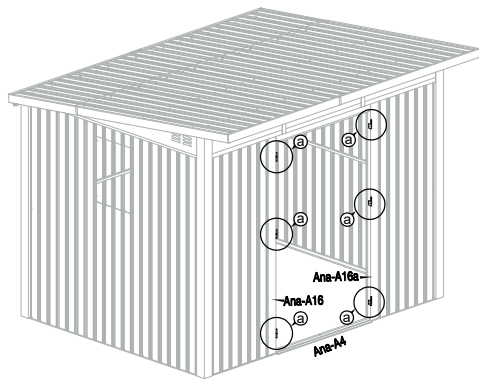
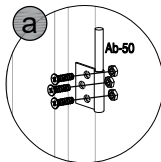

<p>39</p>	 <p>Anx-C41 x8</p>	 <p>Anx-C40 x8</p>	
-----------	---	---	--



<p>40</p>	 <p>Ab-50 x8</p>	 <p>Anx-A43 x18</p>	
-----------	---	--	--



41	 Ac-A29 x1	 Ac-A29a x1	 Ana-54 x1	 Ana-55 x1	 Ana-56 x1	 Ana-57 x1	 Ana-58 x3
----	--	---	--	--	--	--	--

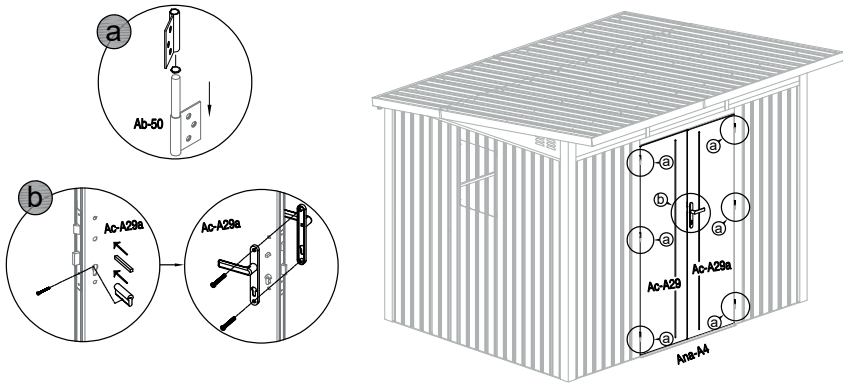

42	 Ana-P6 x1	 Ana-C41 x1	
----	--	---	--

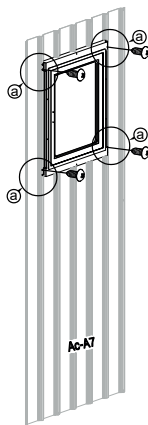
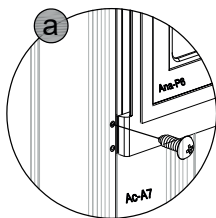
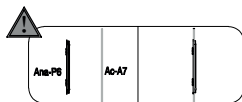

43	 Ana-P7 x1	 Anx-C41 x10	
-----------	--	--	--

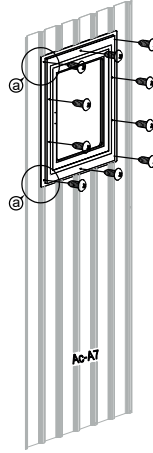
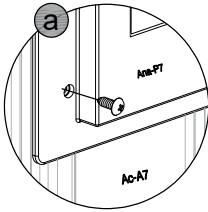
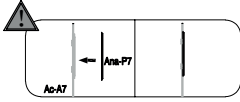

44	 Ana-P8 x1	 Ana-A42 x2	
-----------	--	---	--

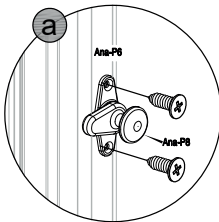

45



Anx-C37 x5.3M

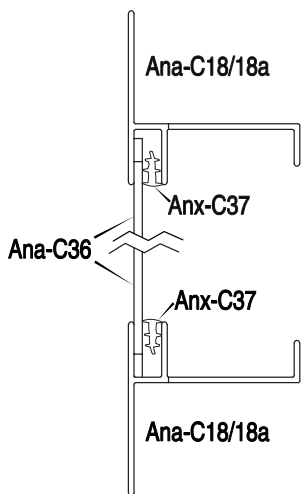

46

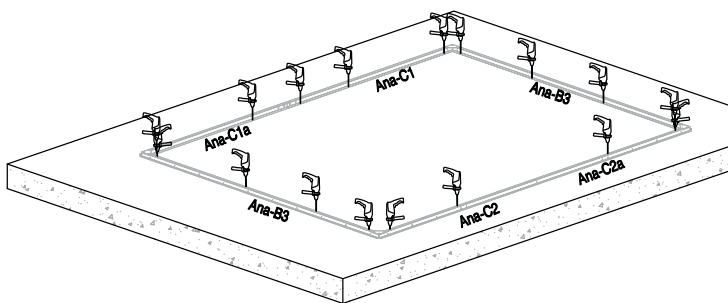
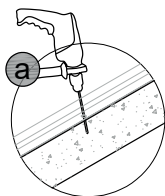
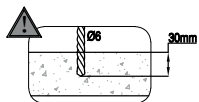
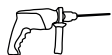

47

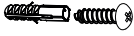

Ana-C45 [x17]

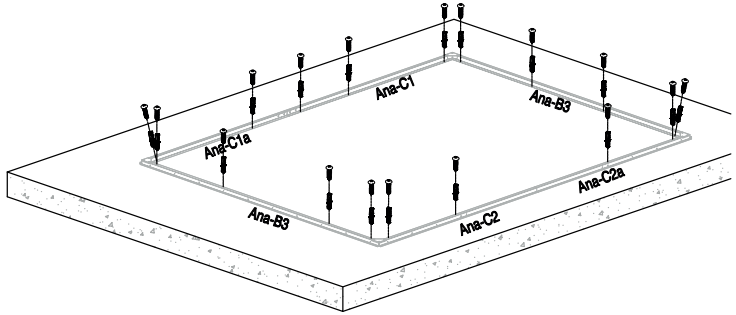
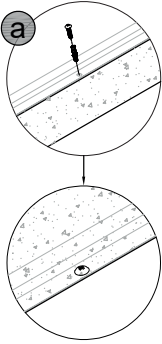

۲۷

