

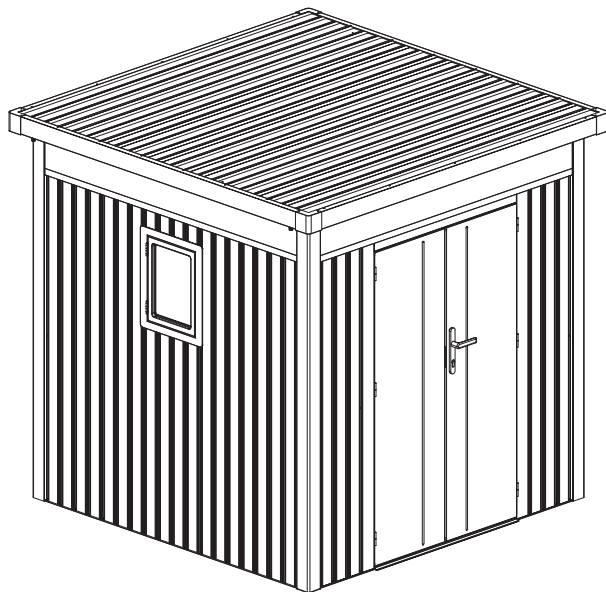

Manual

Garden house G21

Atlanta 529



EN DE CZ SK HU PL HR SLO

۱۲۱



Thank you for purchasing our product.

Before using this unit, please read this manual.

Assembly instructions:

Prior to the assembly please read all instructions and information carefully. The garden house has to be anchored to its base in order to prevent damage. The base is not included in the delivery and it has to be built separately.

Check whether you have all parts which are necessary for the assembly.

Please mind your own safety.

1. 2-3 persons are required for the assembly of this garden house.
2. Use protective clothing and gloves as some parts might be sharp.
3. During the assembly no children or pets should be present in the working area.
4. Do not stand on the roof with all your weight.

Care and maintenance:

1. Clean the house using cloth and water
2. Keep the rails of the sliding door clean and free of any objects that might restrain the door's fluent movement.
3. In case of snowfall remove the snow from the roof regularly.
4. The house is not designed for living but only for storage purposes.

The English version of the manual is an exact translation of the original manufacturer's instructions.

Images used in this manual are for illustrational purposes only and may differ from the actual product.



Vielen Dank für den Kauf unseres Produktes.

Bevor Sie dieses Gerät verwenden, lesen Sie diese Anleitung.

Montageanleitung:

Vor der Montage lesen Sie bitte alle Anweisungen und Angaben vorsichtig. Das Gartenhaus muss auf dem Fundament verankert sein um eine Beschädigung zu verhindern. Das Fundament ist nicht im Lieferumfang enthalten und muss separat angelegt werden.

Überprüfen Sie, ob alle Teile, die für die Montage notwendig sind, vorhanden sind.

Bitte beachten Sie zu Ihrer eigenen Sicherheit.

1. Für die Montage dieses Gartenhauses sind 2-3 Personen erforderlich.
2. Tragen Sie Schutzkleidung und Arbeitshandschuhe, da einige Teile scharfe Kanten haben können.
3. Während des Zusammenbaus sollten sich keine Kinder oder Tiere im Arbeitsbereich aufhalten.
4. Sie sollten sich nicht mit ihrem vollen Gewicht auf das Dach stellen.

Wartung und Pflege:

1. Reinigen Sie das Haus mit Putzlappen und Wasser.
2. Halten Sie die Schienen der Schiebetür sauber und frei von jeglichen Gegenständen, die möglicherweise eine flüssige Bewegung der Tür behindern könnten.
3. Bei Schneefall entfernen Sie regelmäßig den Schnee vom Dach.
4. Das Haus ist nicht geeignet um darin zu wohnen, sondern nur zu Lagerzwecken konzipiert.

Die deutsche Version der Anleitung ist eine genaue Übersetzung der Anleitung des Herstellers.

Die in diesem Handbuch verwendeten Bilder dienen nur zur Illustration und können nicht genau das Produkt entsprechen.



Děkujeme za nákup našeho výrobku.

Před použitím si prosím přečtěte tento návod.

Montážní návod:

Dříve, než začnete s montáží, pečlivě si prostudujte všechny pokyny a informace. Domek musí být řádně ukotven k základové desce, aby nedošlo při silném větru k jeho poškození nebo zničení. Základna není součástí balení, je nutné si ji vybudovat samostatně.

Zkontrolujte, zda máte všechny potřebné díly pro stavbu domku.

Dbejte na svoji bezpečnost.

1. Domek montujte ve 2-3 lidech.
2. Při montáži používejte ochranný oděv a rukavice, protože některé části mohou být ostré.
3. V době montáže by se po staveništi neměly pohybovat děti a domácí zvířata.
4. Nikdy nestůjte na střeše celou svou vahou.

Péče a údržba:

1. Domek čistěte za pomoci hadru a vody.
2. Uchovávejte kolejničky posuvu dveří v čistotě, odstraňte předměty, které brání jejich snadnému klouzání.
3. V případě sněžení pravidelně odklízejte ze střechy domku napadaný sníh.
4. Domek není určen pro bydlení, ale pro ukládání věcí.

Česká verze návodu je přesným překladem originálního návodu výrobce.

Fotografie použité v manuálu jsou pouze ilustrační a nemusí se přesně shodovat s výrobkem.



Ďakujeme za nákup nášho výrobku.

Pred použitím si prosím prečítajte tento návod.

Návod na montáž:

Pred montážou si pozorne prečítajte všetky pokyny a informácie. Domček musí byť riadne ukotvený k základnej doske, aby pri silnom vetre nedošlo k jeho poškodeniu alebo zničeniu. Základňa nie je súčasťou balenia, je nutné ju vybudovať samostatne.

Skontrolujte, či máte všetky potrebné diely na stavbu domčeka.

Dbajte na svoju bezpečnosť.

1. Na montáž domčeka sú potrebné 2-3 osoby.
2. Pri montáži používajte ochranný odev a rukavice, pretože niektoré časti môžu byť ostré.
3. Počas montáže by sa v pracovnom prostredí nemali pohybovať deti ani domáce zvieratá.
4. Nikdy nestojte na streche celou svojou váhou.

Starostlivosť a údržba:

1. Domček čistite pomocou handry a vody.
2. Uchovávejte koľajnice posuvu dverí čisté a odstraňujte všetky predmety, ktoré by bránili jednoduchému posuvu.
3. V prípade sneženia pravidelne zo strechy domčeka odstraňujte napadaný sneh.
4. Domček nie je určený na bývanie, ale výhradne na ukladanie vecí.

Slovenská verzia návodu je presným prekladom originálneho návodu výrobcu.

Fotografie použité v návode sú len ilustračné a nemusia sa presne zhodovať s výrobkom.



Köszönjük, hogy megvásárolta termékünket.

Használat előtt kérjük olvassa el a használati útmutatót.

Telepítési útmutató:

Telepítés előtt figyelmesen olvassa el az összes utasítást és információt. A házat szilárdan és stabilan, egy alapra kell rögzíteni, hogy az erős szélben ne mozduljon el, vagy esetleg ne menjen tönkre. Az alapot a csomag nem tartalmazza, ezt egyénileg kell biztosítani. Az összeszerelés előtt ellenőrizze, hogy megvan-e minden alkatrész.

Ügyeljen a biztonságra.

1. A ház összeszereléséhez legalább 2-3 ember kell.
2. Telepítés közben vegyen fel védőöltözetet és kesztyűt, mert néhány alkatrész éles lehet.
3. A szerelés közben ne legyenek se gyermek, se háziállat ne tartózkodjon a közelben.
4. Soha ne nehezedjen a tetőre teljes súllyal.

Ápolás és karbantartás:

1. A házat ronggyal és vízzel tisztítsa.
2. A tolóajtó síneit mindig tartsa tisztán és távolítsa el azon tárgyakat, melyek akadályozhatják a gördülést.
3. Havazás esetén mindig söpörje le a havat a tetőről.
4. A ház nem alkalmas lakhatásra, csupán eszközök tárolására.

A magyar használati utasítás a gyártótól kapott verzió pontos fordítása.

A kézikönyvben használt fényképek csak illusztrációk, nem egyeznek meg pontosan a termékkel.



Dziękujemy za zakup naszego produktu.

Przed użyciem prosimy starannie przeczytać tę instrukcję.

Instrukcja montażu:

Przed przystąpieniem do montażu należy dokładnie zapoznać się z zaleceniami i informacjami. Domek musi być prawidłowo umocowany do płyty fundamentowej, aby przy silnym wietrze nie doszło do jego uszkodzenia lub zniszczenia.

Płyta fundamentowa nie stanowi elementu wyposażenia, należy ją wykonać we własnym zakresie.

Należy sprawdzić kompletność wszystkich elementów niezbędnych do budowy domku.

Należy zadbać o własne bezpieczeństwo.

1. Domek powinien być montowany przez ekipę składającą się z 2-3 pracowników.
2. Podczas prac montażowych należy korzystać z odzieży ochronnej i rękawic dlatego, że niektóre z części mogą mieć ostre krawędzie.
3. Podczas prac montażowych na placu budowy niepożądana jest obecność dzieci i zwierząt domowych.
4. Nigdy nie należy całą swoją wagą stać na dachu domku.

Pielęgnacja i konserwacja:

1. Do czyszczenia domku używać ścierki i wody.
2. Należy dbać o utrzymanie w czystości szyn do przesuwu drzwi, usuwać przedmioty hamujące przesuwanie drzwi.
3. W razie opadów śniegu, z dachu domku należy usuwać zalegający śnieg.
4. Domek nie jest przeznaczony do zamieszkania lecz tylko do przechowywania i składowania przedmiotów.

Polska wersja językowa instrukcji jest dokładnym tłumaczeniem oryginalnej instrukcji producenta.

Zdjęcia wykorzystane w tym podręczniku są jedynie ilustracją i nie może dokładnie dopasować produkt.

Hvala vam na kupnji našeg proizvoda.

Molimo pročitajte ovaj priručnik prije upotrebe.

Upute za montažu:

Prije početka montaže pažljivo pročitajte sve upute i informacije. Kućica mora biti pravilno pričvršćena za temeljnu ploču kako bi se spriječilo oštećenje ili uništenje uslijed jakog vjetra. Podnožje nije uključeno u pakiranje, mora se zasebno izgraditi.

Provjerite imate li sve potrebne dijelove za izgradnju kuće.

Vodite računa o svojoj sigurnosti.

1. Kućicu sastavljaju 2-3 osobe.
2. Tijekom montaže nosite zaštitnu odjeću i rukavice jer neki dijelovi mogu biti oštri.
3. Djeca i kućni ljubimci ne smiju biti na gradilištu tijekom montaže.
4. Nikada ne stojte na krovu punom težinom.

Njega i održavanje:

1. Kućicu čistite krpom i vodom.
2. Klizne vodilice vrata održavajte čistima, uklonite predmete koji sprječavaju njihovo lako klizanje.
3. U slučaju snježnih padalina redovito uklanjajte snijeg s krova kuće.
4. Kućica nije namijenjena za stanovanje, već za pohranu stvari.

Hrvatska verzija priručnika točan je prijevod originalnih uputa proizvođača.

Slike korištene u ovom priručniku služe samo za ilustraciju i mogu se razlikovati od stvarnog proizvoda.

Hvala za nakup našega izdelka.

Pred uporabo preberite ta priročnik.

Navodila za montažo:

Pred začetkom montaže natančno preberite vsa navodila in informacije. Hiša mora biti pravilno pritrjena na osnovno ploščo, da preprečite poškodbe ali uničenje v močnem vetru. Podstavek ni vključen v paket, zgraditi ga je treba ločeno.

Preverite, ali imate vse potrebne dele za gradnjo hiše.

Poskrbite za svojo varnost.

1. Hišo sestavljajo 2–3 osebe.
2. Med montažo nosite zaščitna oblačila in rokavice, saj so nekateri deli lahko ostri.
3. Otroci in hišni ljubljenci med montažo ne smejo biti na gradbišču.
4. Nikoli ne stojte na strehi s polno težo.

Nega in vzdrževanje:

1. Hišo čistite s krpo in vodo.
2. Drsnice tirnice vrat vzdržujte čiste, odstranite predmete, ki preprečujejo njihovo enostavno drsenje.
3. V primeru sneženja redno odstranjujte sneg s strehe hiše.
4. Hiša ni namenjena bivanju, temveč shranjevanju stvari.

Slovenska različica navodil za uporabo je natančen prevod originalnih proizvajalčevih navodil.

Fotografije, uporabljene v navodilih, so samo ilustrativne in se morda ne ujemajo popolnoma z izdelkom.



EN Installation

DE Montage

CZ Montáž

SK Montáž





















HU Összeszerelés

























PL Montaż

HR Sastavljanje

SLO Montáž

EN Parts list**DE** Teilleiste**CZ** Seznam dílů**SK** Zoznam dielov**HU** Alkatrész lista**PL** Wykaz części**HR** Popis dijelova**SL** Seznam delov

#		mm	PCS	
				
Ac-A1		2064	x1	
Ana-A2		2064	x1	
Ana-B3		2064	x2	
Ana-A4		1130	x1	
				
Ana-A5		2124	x4	
Ac-A6		1900	x8	
Ac-A7		1900	x1	
Ac-A8		1900	x2	
Ac-A9		2024	x1	
Ana-B10		2063	x2	
Ac-A11		464	x2	
Ana-A12		2024	x1	
Ana-A13		2024	x1	
Ana-B14		2063	x2	
Ana-A16		1900	x1	
Ana-A16a		1900	x1	
Ana-A17			1087.5	x1
Ana-A18			2077	x8
Ana-A22b		223	x4	
Ana-A22a		223	x4	
Ana-A23		2017	x2	
Ana-A36		2077	x3	
Ana-A38		2077	x1	
Ana-B26		2142.5	x2	
Ana-A27		2236	x2	
Ana-B27		2248	x2	
				
Ac-A29		1804	x1	
Ac-A29a		1804	x1	

#		mm	PCS
			
Ana-A24		2254	x5
Ana-A25		2254	x1
Ana-A25a		2254	x1
Ana-A28		2160	x2
Ana-B28		2159.5	x2
			
Ab-4			x12
Ana-B37			16.5M
Ana-P1			x4
Ana-P2			x4
Ana-P6			x1
Ana-P7			x1
Ana-P8			x1
Ab-50			x6
Ana-54			x1
Ana-55			x1
Ana-56			x1
Ana-57			x1
Ana-58		M5x45	x3
Ana-B40			x159
Ana-B41		ST4x10	x279
Ana-A42		ST4x10	x2
Ana-A43		M4x10	x18
Ana-A44		M5x8	x4
Ana-B45		ST4x25	x16

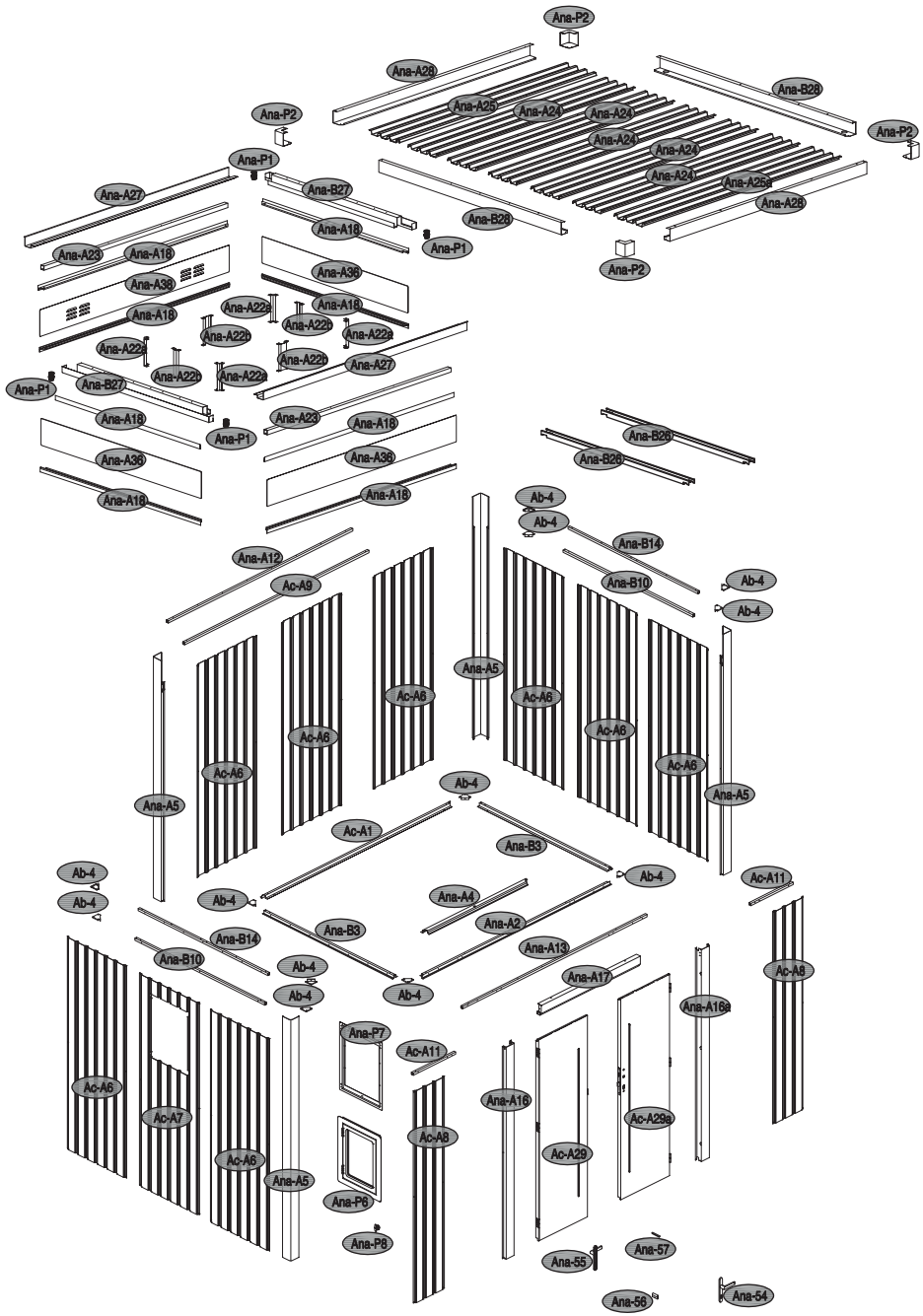

EN Dimensions

DE Abmessungen

CZ Rozměry

SK Rozmery

HU Méretek

PL Wymiary

HR Dimenzije

SL Dimenzije

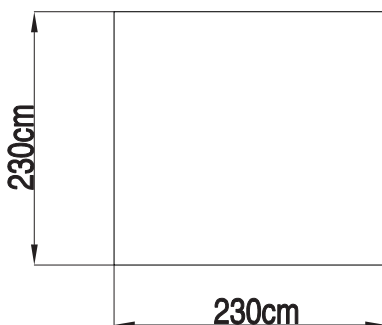
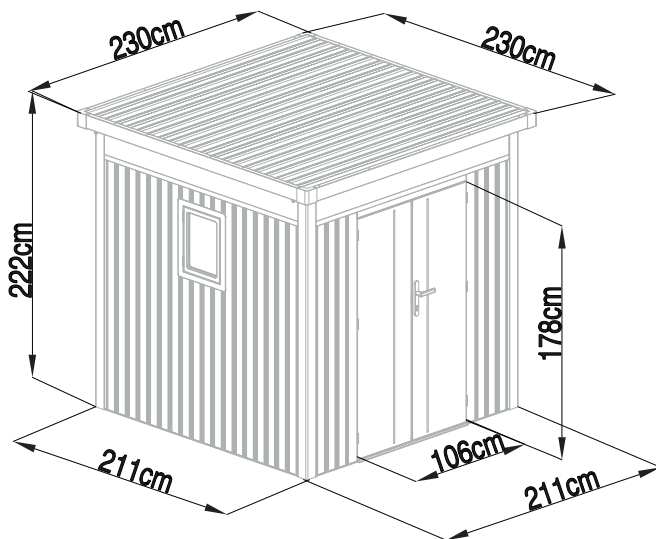

EN Tools you will need

CZ Nástroje, které budete potřebovat

HU Szükséges eszközök és szerszámok

HR Alati koji će vam trebati

DE Werkzeuge, die Sie brauchen

SK Nástroje, ktoré budete potrebovať

PL Przyrządy i narzędzia, które będą potrzebne

SLQ Orodja, ki jih boste potrebovali

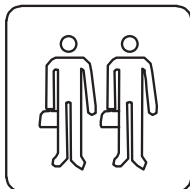
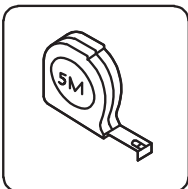
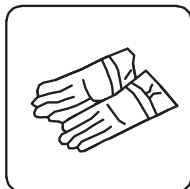
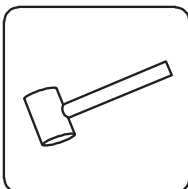
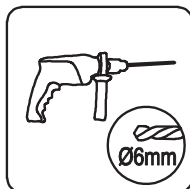
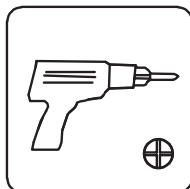

EN Assembly instructions

DE Montageanleitung

CZ Návod k montáži

SK Návod k montáži

HU Szerelési útmutató

PL Instrukcja montażu

HR Upute za montažu

SLO Navodila za namestitev

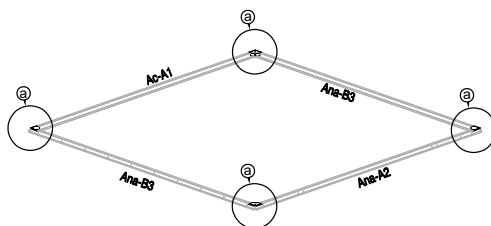
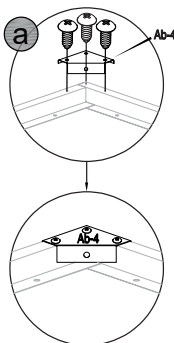
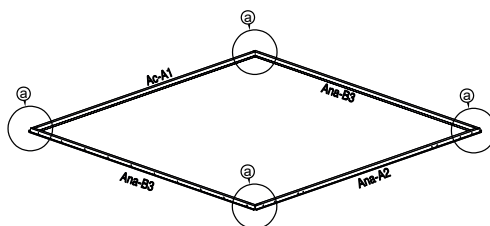
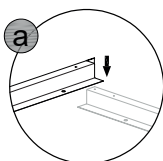
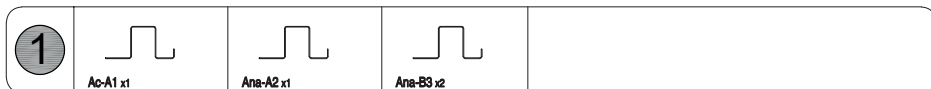

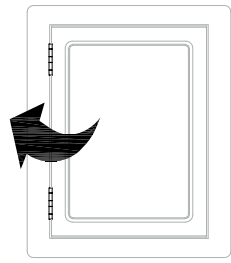



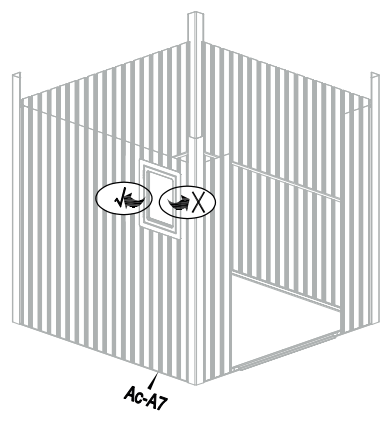
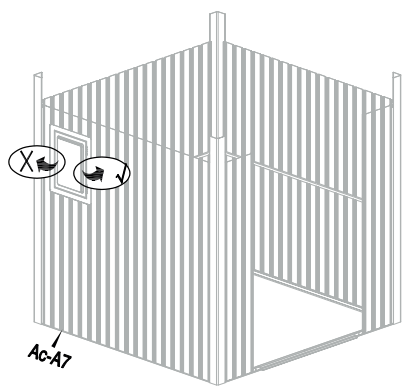
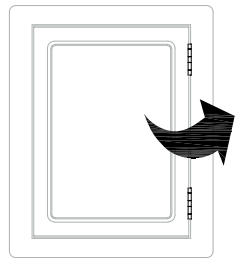

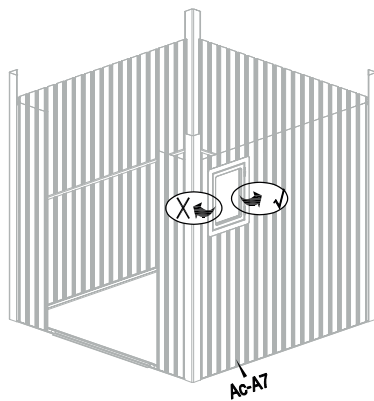
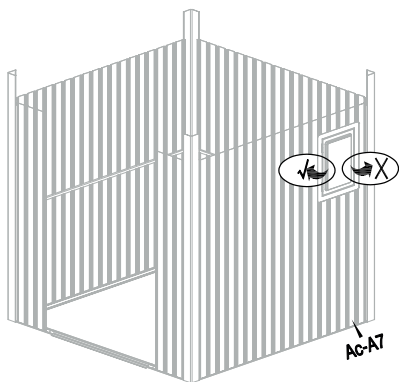
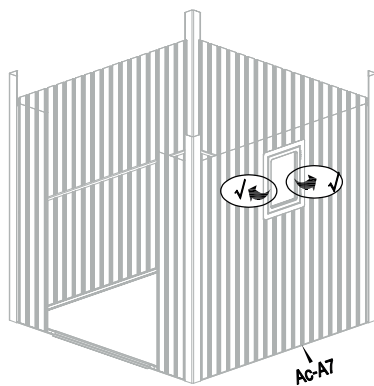
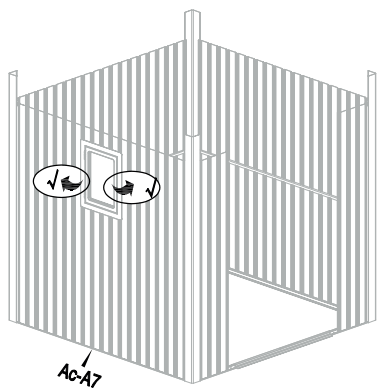

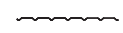

Or



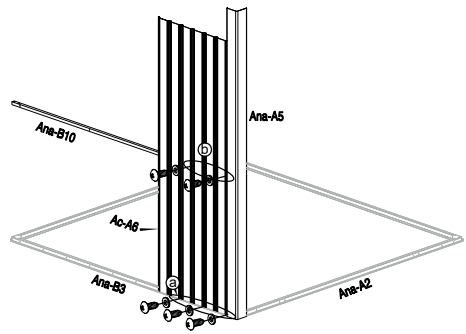
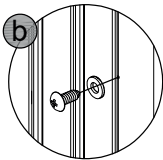
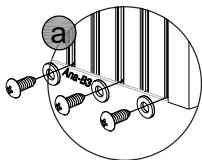
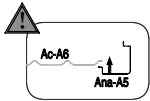

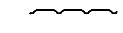



3	 Ac-A6 x1	 Ana-A5 x1	 Ana-B10 x1	 Ana-B41 x5	 Ana-B40 x5	
----------	---	--	---	---	---	--

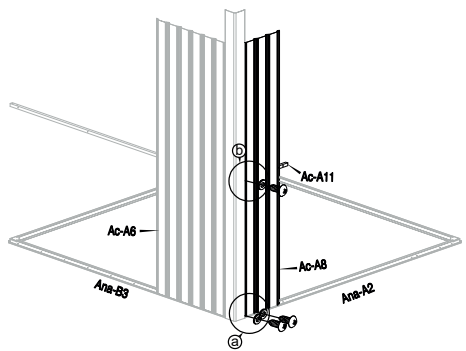
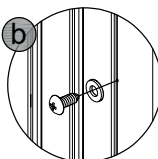
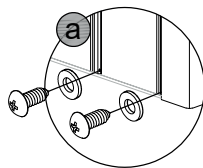





4	 Ac-A8 x1	 Ac-A11 x1	 Ana-B41 x3	 Ana-B40 x3	
----------	---	--	---	---	--

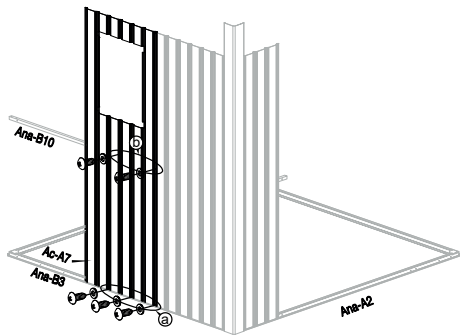
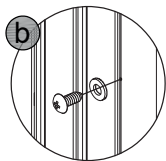





5	 Ac-A7 x1	 Ana-B41 x5	 Ana-B40 x5	
---	---	---	---	--

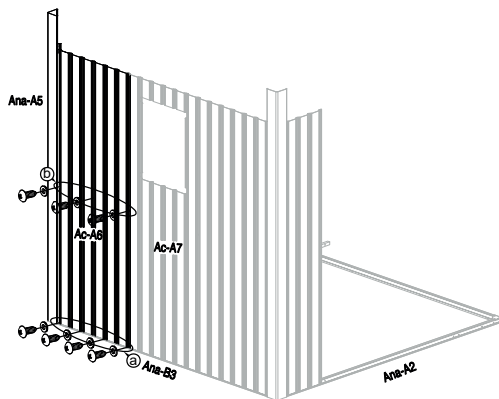
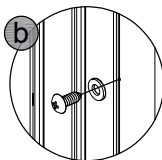
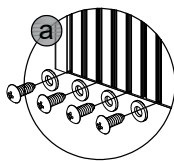



6	 Ac-A6 x1	 Ana-A5 x1	 Ana-B41 x7	 Ana-B40 x7	
---	---	--	---	---	--



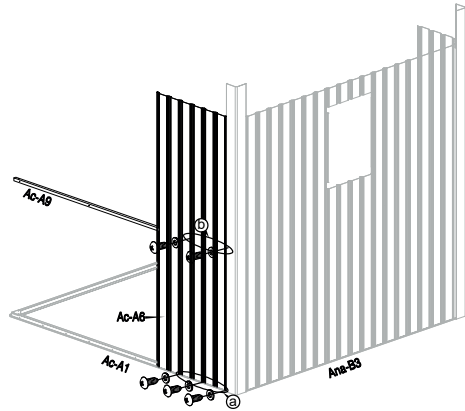
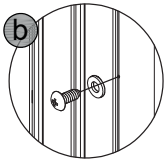
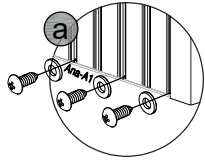



7	 Ac-A6 x1	 Ac-A9 x1	 Ana-B41 x5	 Ana-B40 x5	
---	---	---	---	---	--

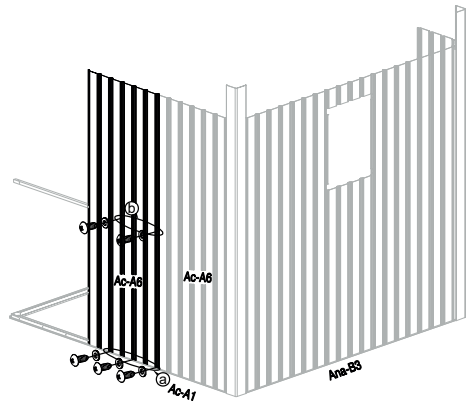
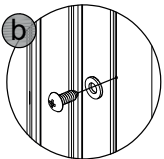
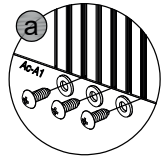





8	 Ac-A6 x1	 Ana-B41 x5	 Ana-B40 x5	
---	---	---	---	--

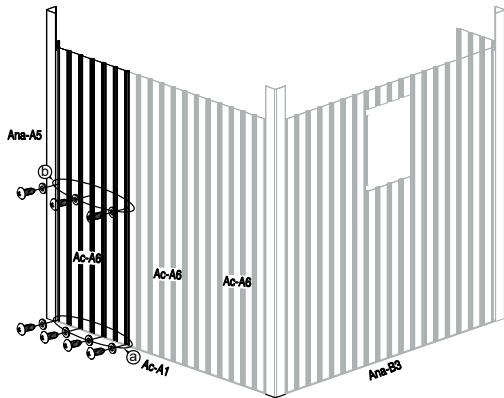
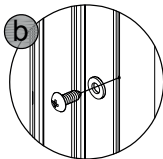
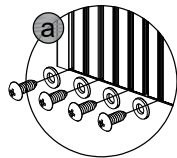

9	 Ac-A6 x1	 Ana-A5 x1	 Ana-B41 x7	 Ana-B40 x7	
----------	---	--	---	---	--





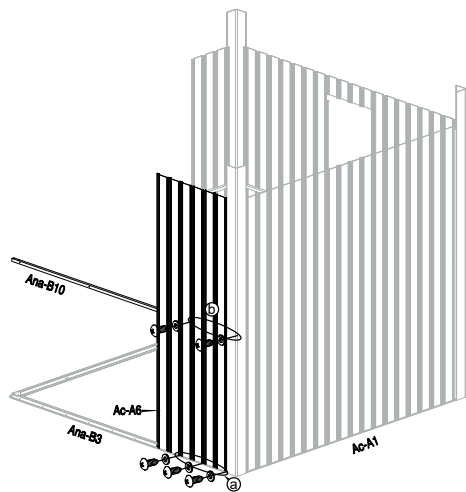
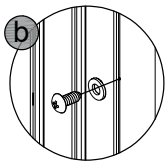
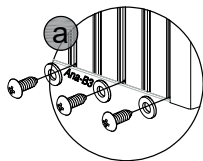

10	 Ac-A6 x1	 Ana-B10 x1	 Ana-B41 x5	 Ana-B40 x5	
-----------	---	---	---	---	--

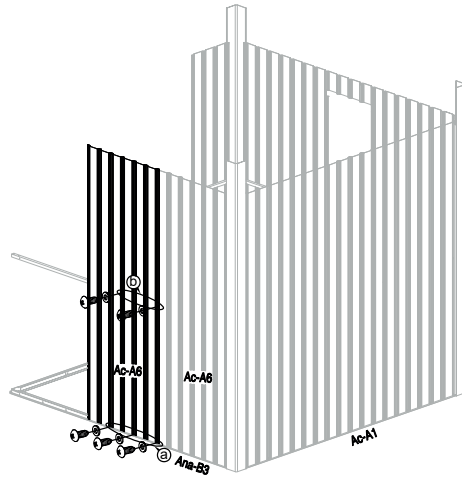
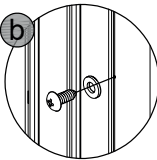
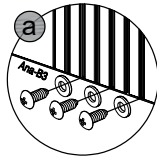





11	 Ac-A6 x1	 Ana-B41 x5	 Ana-B40 x5	
-----------	---	---	---	--

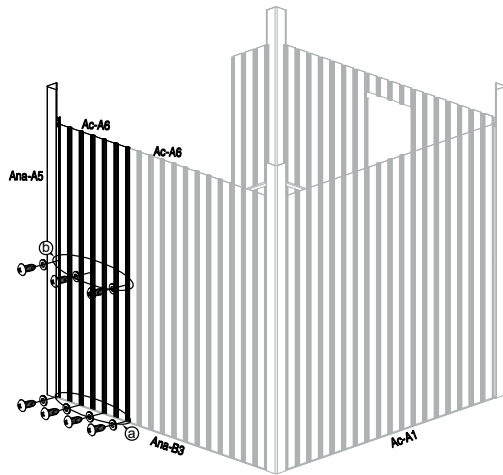
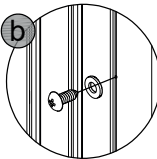
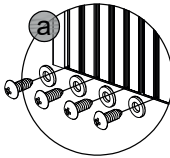

12	 Ac-A6 x1	 Ana-A5 x1	 Ana-B41 x7	 Ana-B40 x7	
-----------	---	--	---	---	--



13	 Ac-A8 x1	 Ac-A11 x1	 Ana-B41 x3	 Ana-B40 x3	
-----------	---	--	---	---	--

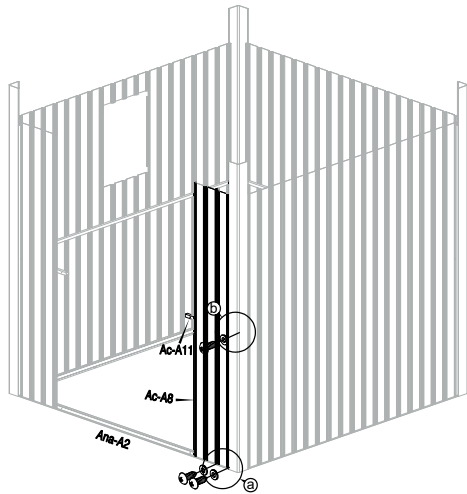
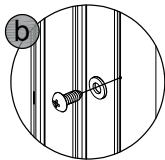
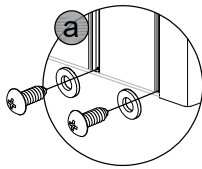

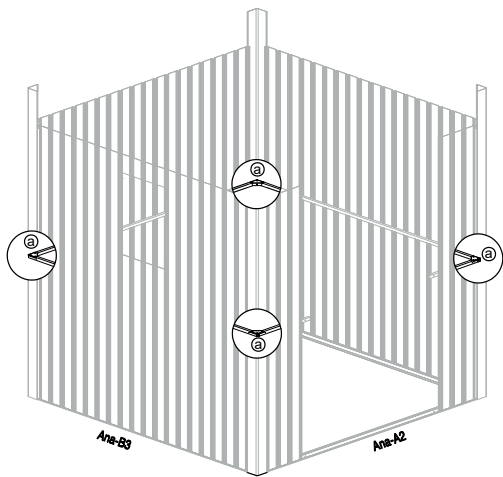
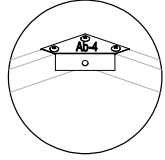
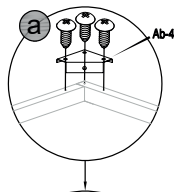

14	 Ab-4 x4	 Ana-B41 x12			
-----------	--	--	--	--	--

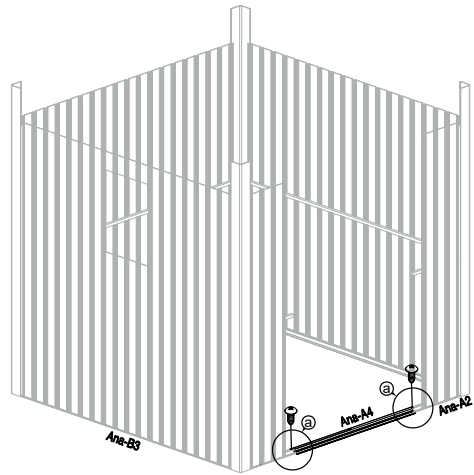
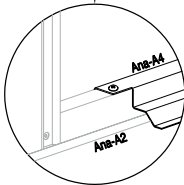
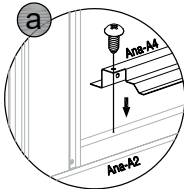
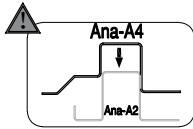

15	 <p>Ana-A4 x1</p>	 <p>Ana-B41 x2</p>	
----	--	---	--

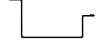



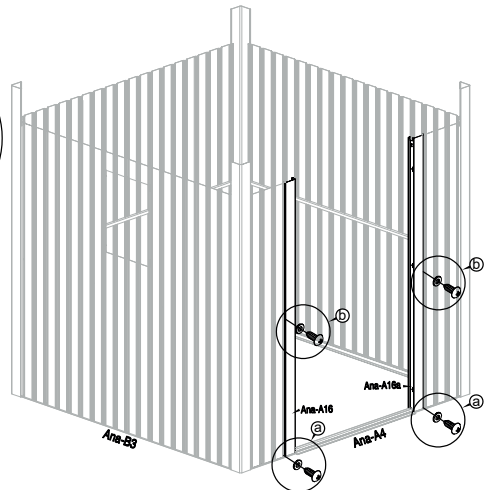
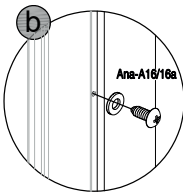
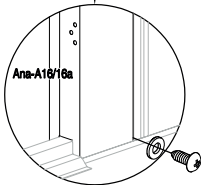
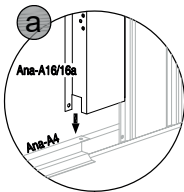

16	 <p>Ana-A16 x1</p>	 <p>Ana-A16a x1</p>	 <p>Ana-B41 x4</p>	 <p>Ana-B40 x4</p>	
----	---	--	---	---	--

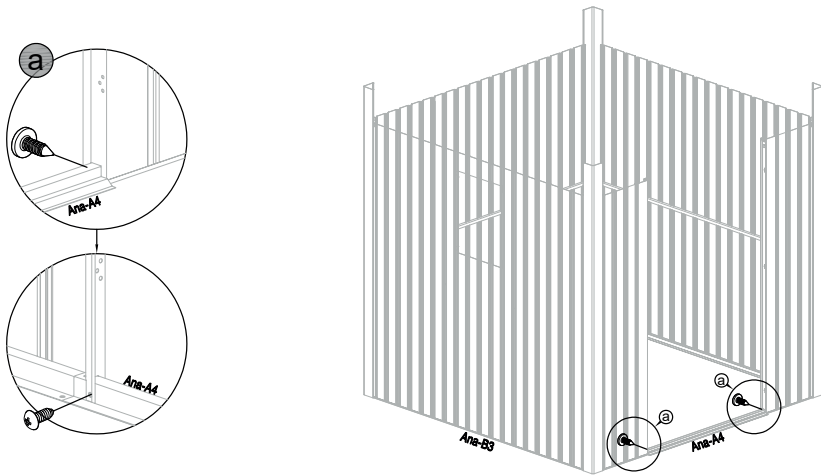





17	 <p>Ana-B41 x2</p>	
----	---	--

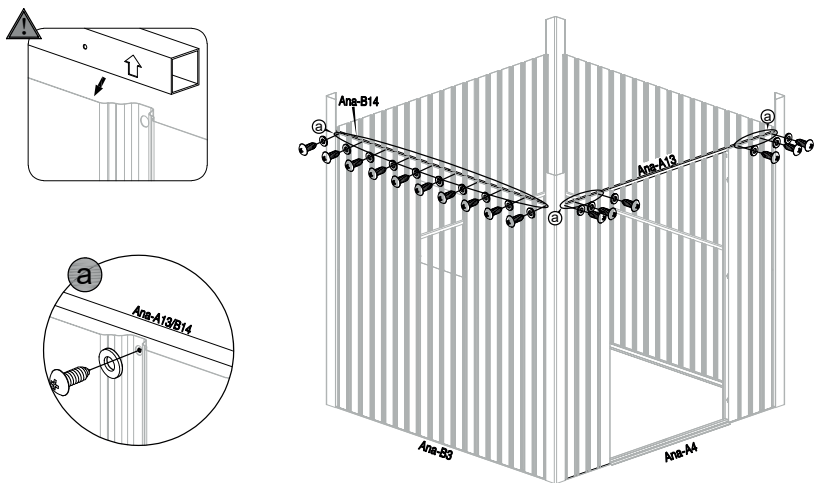

18	 <p>Ana-A13 x1</p>	 <p>Ana-B14 x1</p>	 <p>Ana-B41 x16</p>	 <p>Ana-B40 x16</p>	
----	---	---	--	--	--



19	 Ana-A12 x1	 Ana-B14 x1	 Ana-B41 x22	 Ana-B40 x20	
----	---	---	--	--	--

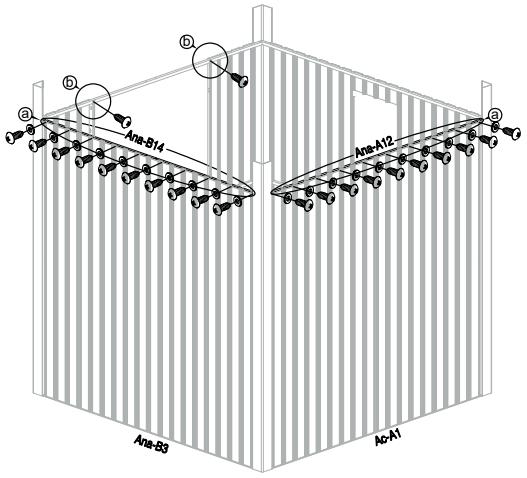
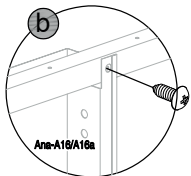
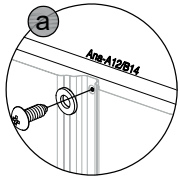
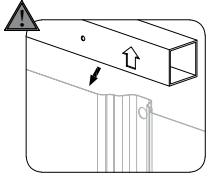

20	 Ab-4 x4	 Ana-B41 x12	
----	--	--	--

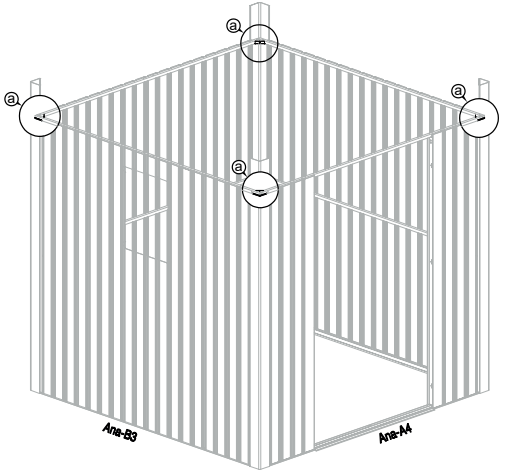
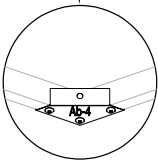
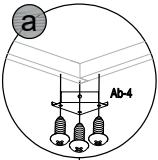

21	 Ana-A17 x1	 Ana-A44 x4	
-----------	---	---	--

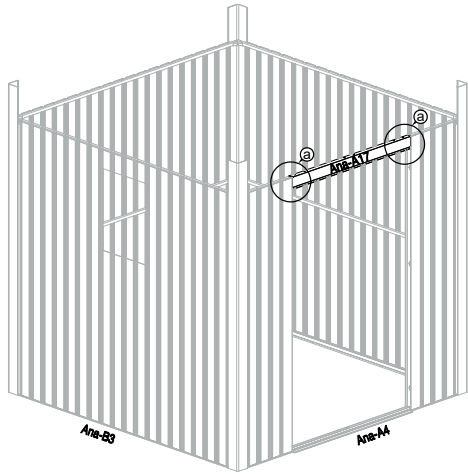
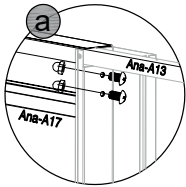
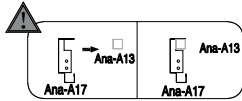

22	 Ana-A18 x4	
-----------	---	--

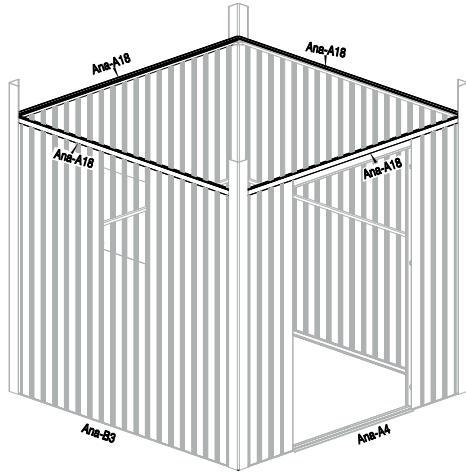
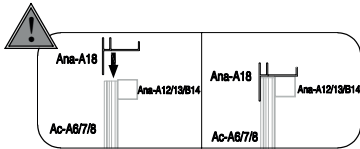

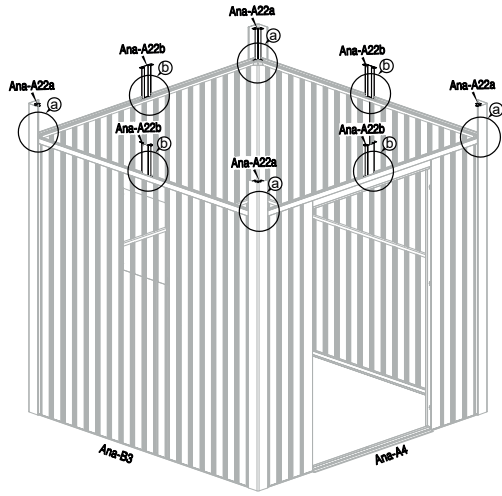
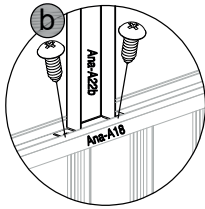
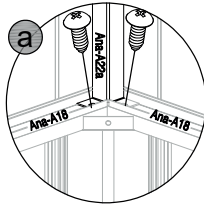

23	 Ana-A22b x4	 Ana-A22a x4	 Ana-B41 x16	
-----------	-----------------	-----------------	-----------------	--



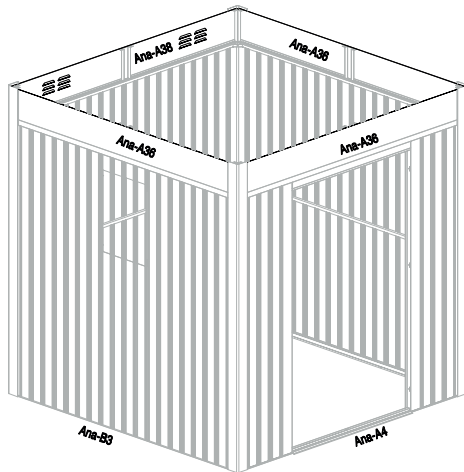
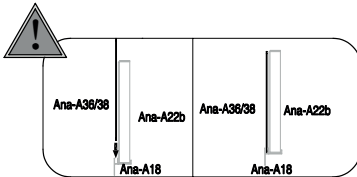
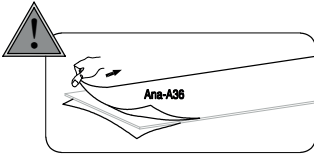

24	 Ana-A36 x3	 Ana-A38 x1	
-----------	----------------	----------------	--

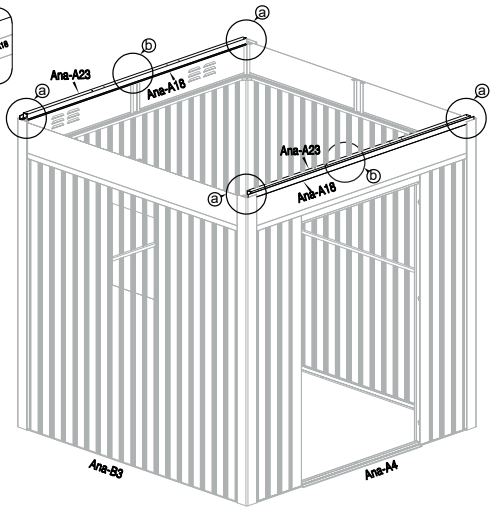
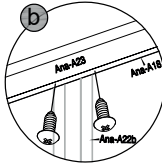
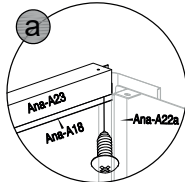
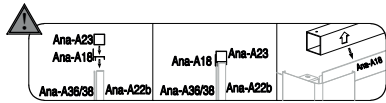

25	 Ana-A23 x2	 Ana-A18 x2	 Ana-B41 x8	
-----------	---	---	---	--



26	 Ana-B27 x2	 Ana-A18 x2	 Ana-B41 x8	
-----------	---	---	---	--

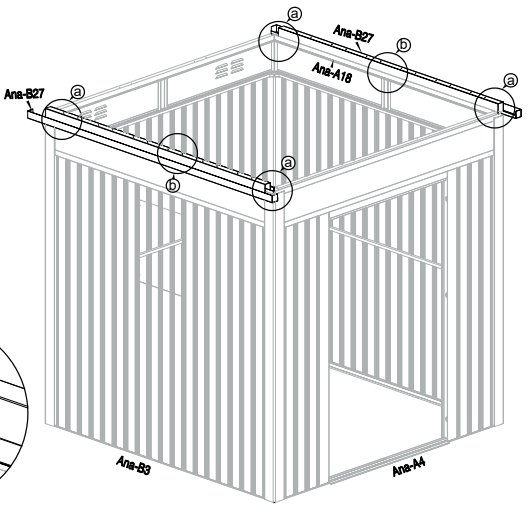
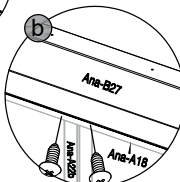
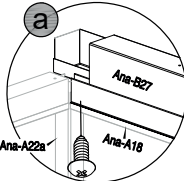
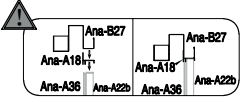

<p>27</p>	 <p>Ana-A27 x2</p>	 <p>Ana-B41 x4</p>	
-----------	---	---	--

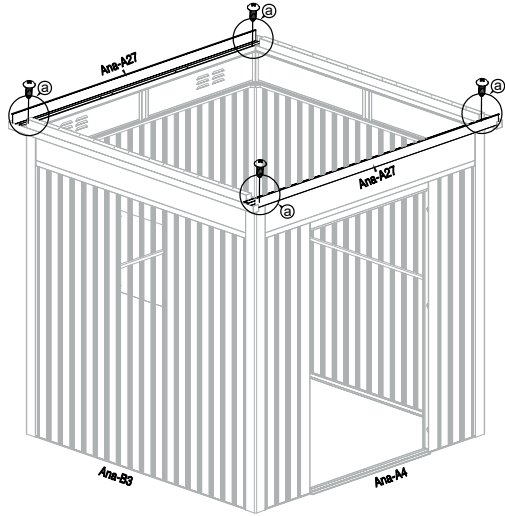
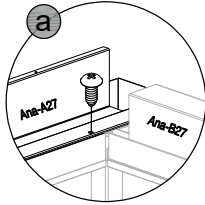

<p>28</p>	 <p>Ana-B26 x2</p>	 <p>Ana-B41 x4</p>	
-----------	---	---	--

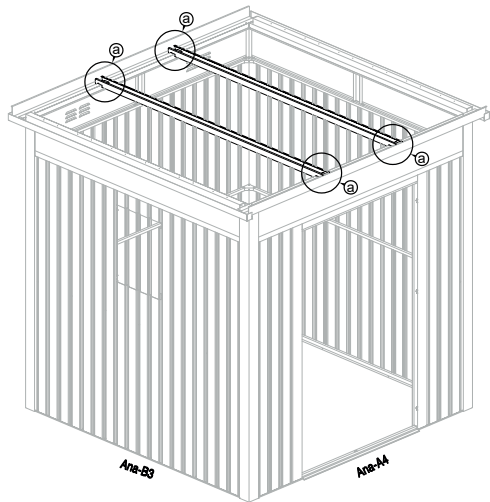
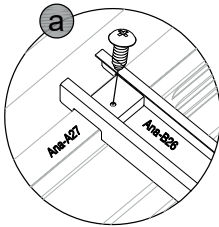

29



Ana-P1 x4

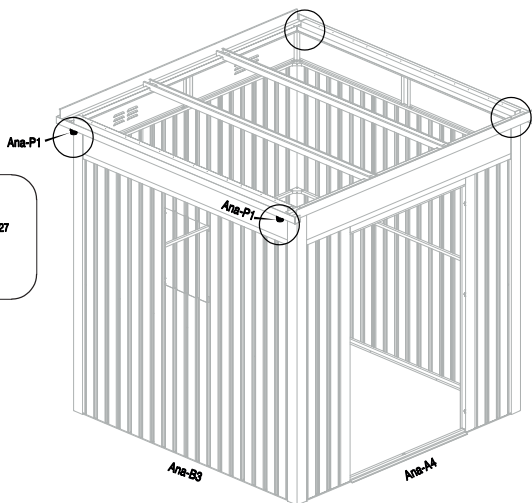

30



Ana-A25 x1



Ana-B41 x2



Ana-B40 x2

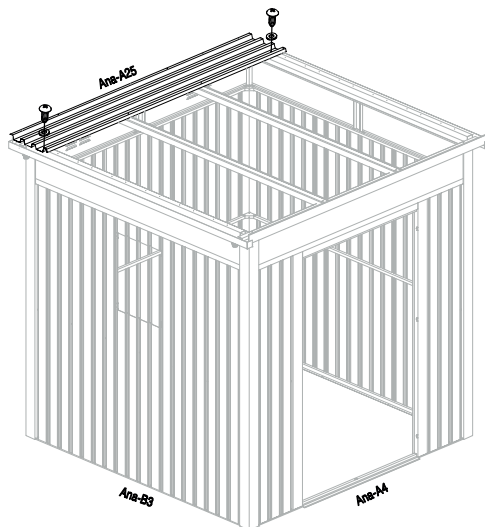
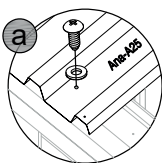

17



<p>31</p>	 <p>Ana-A24 x2</p>	 <p>Ana-B41 x12</p>	 <p>Ana-B40 x12</p>	
------------------	---	--	--	--

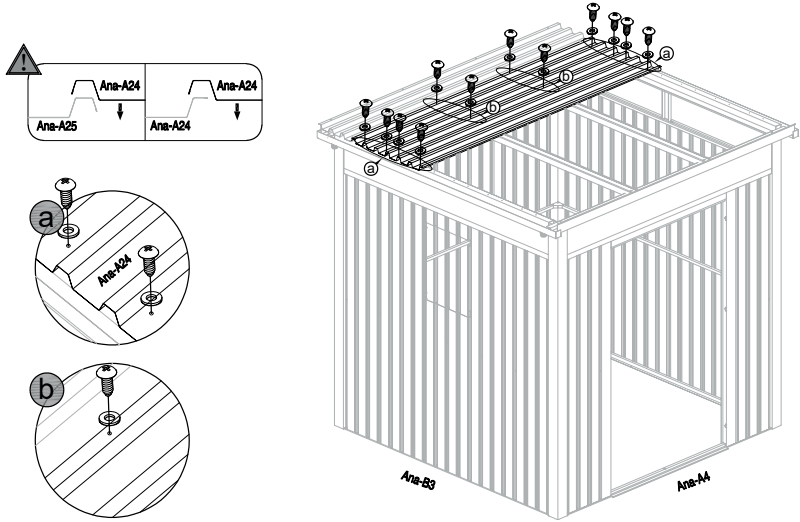



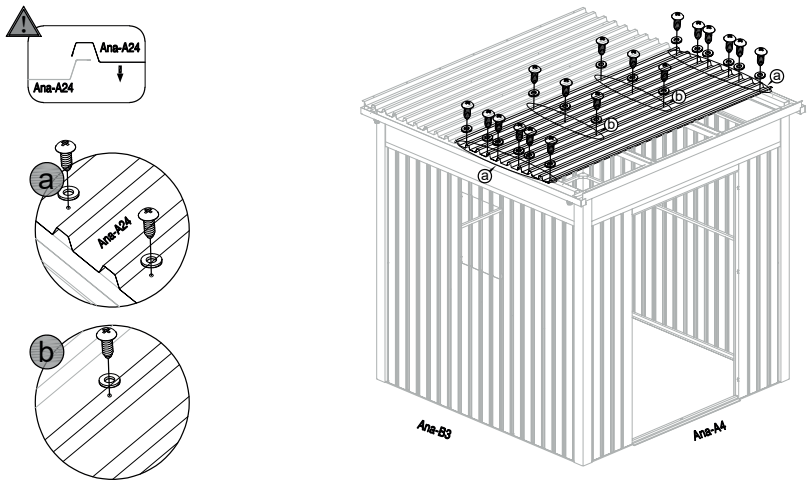

<p>32</p>	 <p>Ana-A24 x3</p>	 <p>Ana-B41 x18</p>	 <p>Ana-B40 x18</p>	
------------------	---	--	--	--

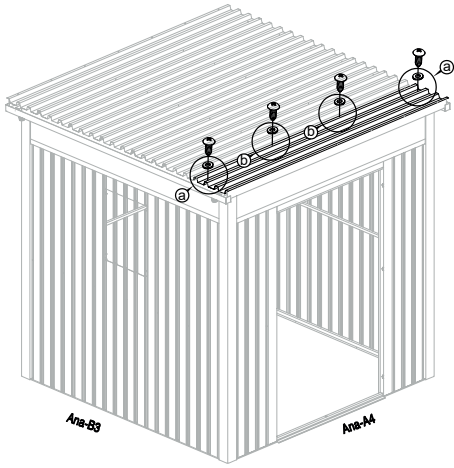
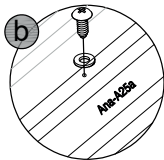
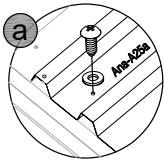
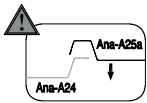

33	 Ana-A25a x1	 Ana-B41 x4	 Ana-B40 x4	
-----------	--	---	---	--



34	 Ana-A28 x2	 Ana-B28 x2	 Ana-B41 x28	 Ana-B40 x28	
-----------	---	---	--	--	--

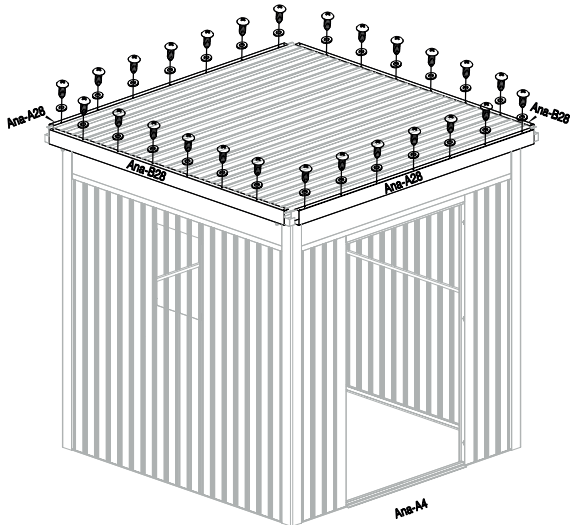
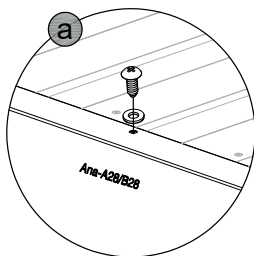



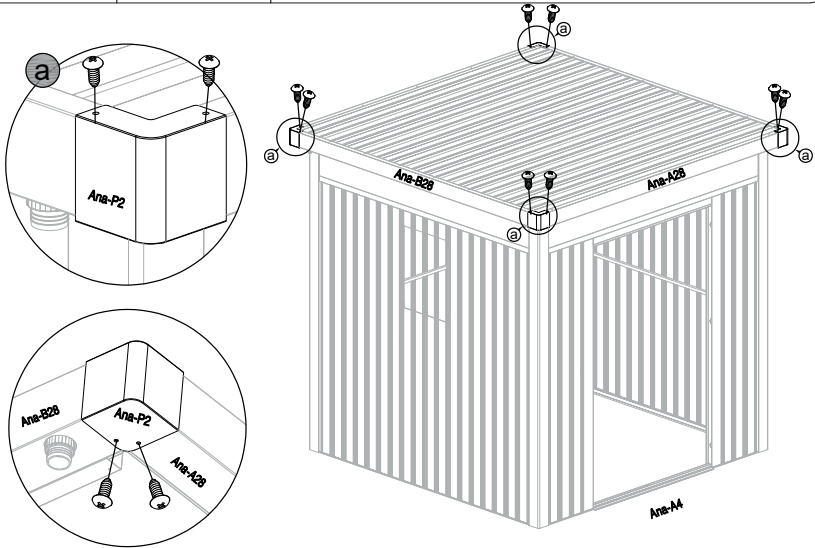

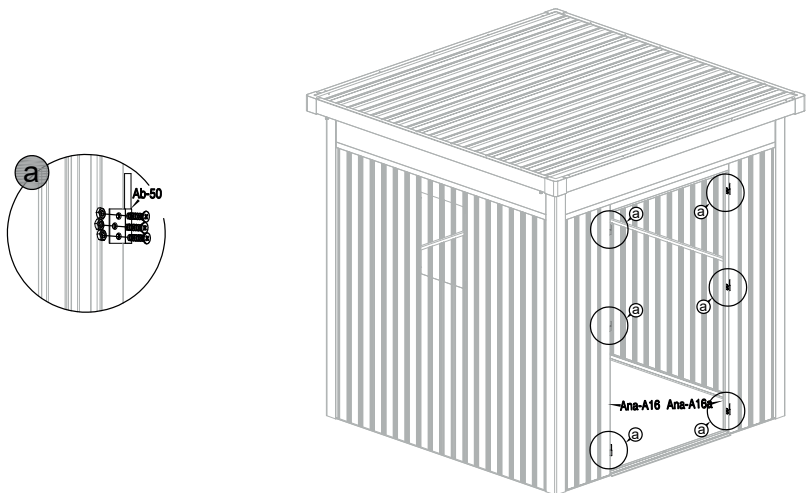

35	 Ana-P2 x4	 Ana-B41 x16	
-----------	--	--	--



36	 Ab-50 x8	 Ana-A43 x18	
-----------	---	--	--



37	 Ac-A29 x1	 Ac-A29a x1	 Ana-54 x1	 Ana-55 x1	 Ana-56 x1	 Ana-57 x1	 Ana-58 x3
-----------	--	---	--	--	--	--	--

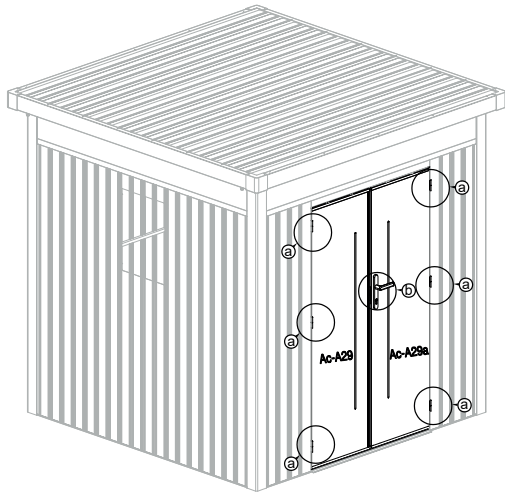
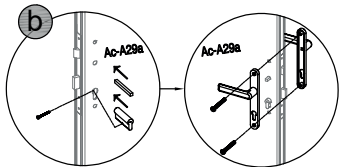
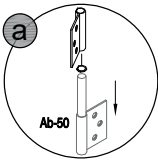

38	 Ana-P6 x1	 Ana-B41 x1
-----------	--	---

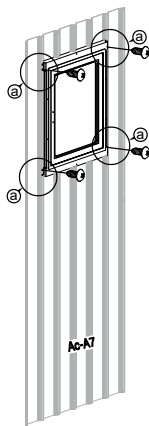
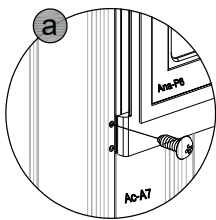
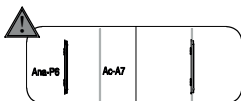

39	 Ana-P7 x1	 Ana-B41 x10	
-----------	--	--	--

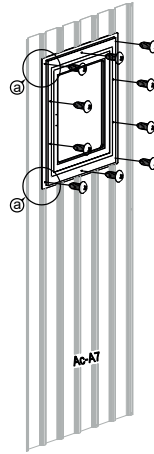
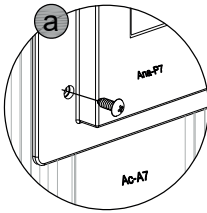
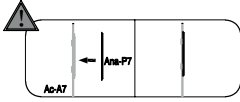

40	 Ana-P8 x1	 Ana-A42 x2	
-----------	--	---	--

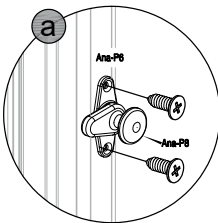

41



Ana-B37 x16.5M

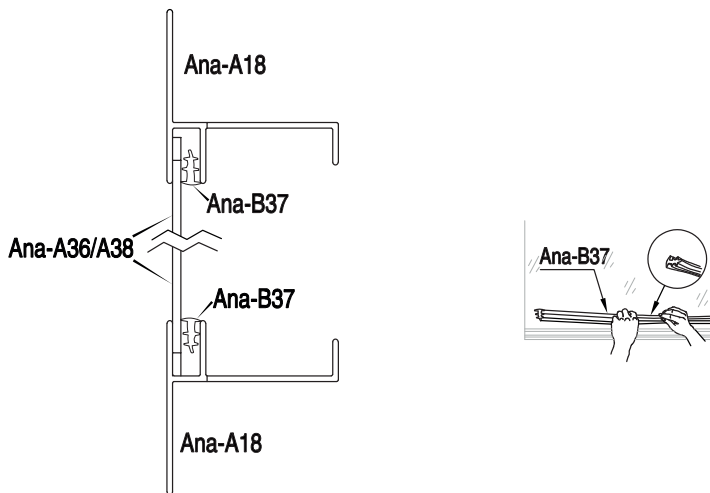

42

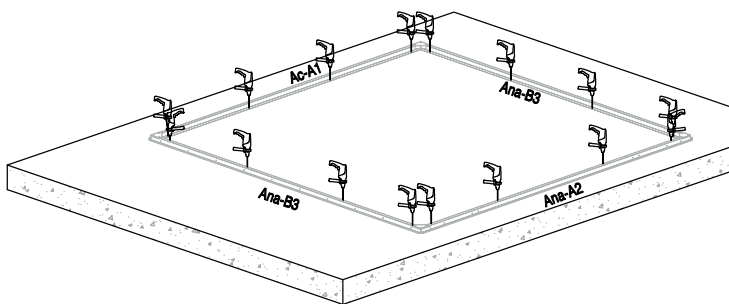
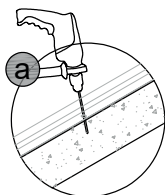
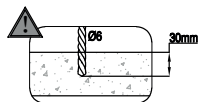

43 Ana-B45 x16

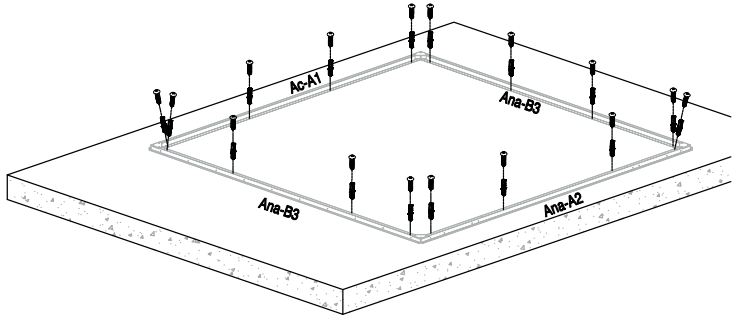
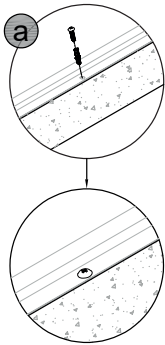

۲۷

